

# TO THE OWNER

Congratulations! We welcome you to the exciting world of motor home travel and camping. You will find it convenient and enjoyable to have all the comforts of home and still enjoy the great outdoors, wherever you choose to go.

Your motor home has been carefully designed, engineered and manufactured to provide dependability as well as safety. Before sliding into the driver's seat, take a few minutes to become familiar with operations and features. This manual was prepared to aid you in the proper care and operation of the vehicle and equipment. We urge you to read it completely. In addition, spend some time with the dealer when you take delivery, you will want to learn all you can about your new motor home.

Your Winnebago motor home is covered by a factory warranty against defects in material and workmanship. This warranty should be validated at once and returned to the factory by your dealer.

Throughout this manual, reference is made to the following terms: Important, Caution and Warning. These terms indicate important information which must be understood and followed. The definitions of these terms are:

## **IMPORTANT**

Indicates a special point of information.

## **CAUTION**

Indicates that a failure to observe can cause damage to equipment.

## **WARNING**

Indicates that failure to observe can cause personal injury or death and possible damage to equipment.



---

OWNER'S NAME

---

STREET ADDRESS

---

CITY AND STATE (OR PROVINCE IN CANADA)

---

VEHICLE IDENTIFICATION NO.

---

DATE OF DELIVERY TO FIRST RETAIL PURCHASER

---

VEHICLE MILEAGE AT TIME OF SUCH DELIVERY

---

SELLING DEALER NAME AND ADDRESS

---

CHASSIS SERIAL NUMBER





## TABLE OF CONTENTS

<b>SECTION 0: INTRODUCTION</b>	
Winnebago-Itasca Travelers Club (WIT) .....	0-2
Exterior Feature Identification:	
C-Body Vehicles .....	0-3, 0-4
A-Body Vehicles .....	0-5, 0-6
<b>SECTION 1: SAFETY PRECAUTIONS</b>	
LP Gas Warning .....	1-2
Formaldehyde Information .....	1-4
Carbon Monoxide Warning .....	1-4
Emergency Exits .....	1-5
<b>SECTION 2: LP GAS SYSTEM</b>	
Safe use of LP Gas Systems .....	2-1
Refilling .....	2-3
LP Gas Pressure Regulator .....	2-4
LP Gas Leaks .....	2-5
LP Gas Detector/Alarm .....	2-5
Winter Usage .....	2-7
<b>SECTION 3: ELECTRICAL SYSTEMS</b>	
12-Volt DC System .....	3-1
110-Volt AC System .....	3-1
External Utility Connection .....	3-1
Ground Fault Interrupter .....	3-5
Battery Information .....	3-5
Auxiliary Battery Disconnect System .....	3-9
Auxiliary Generator .....	3-12
<b>SECTION 4: WATER SYSTEM</b>	
Filling .....	4-1
Sanitizing .....	4-2
<b>SECTION 5: DRAINAGE SYSTEM</b>	
Dumping Holding Tanks .....	5-1
Use of In-Park Sewer System .....	5-1
<b>SECTION 6: INTERIOR FEATURES AND EQUIPMENT</b>	
Sleeping Facilities .....	6-1
Appliances .....	6-3
<b>SECTION 7: TRAVELING WITH YOUR MOTOR HOME</b>	
Loading the Motor Home .....	7-1
Roof Loading .....	7-2
Towing .....	7-2
Vehicle Certification Label .....	7-4, 7-5
<b>SECTION 8: DRIVER CONTROLS AND FEATURES</b>	
Multi-Function Signal Lever .....	8-2
Automotive Heating - A/C .....	8-2 thru 8-4
Coach Leveling Systems .....	8-6 thru 8-9
Rear Monitor System .....	8-10
Door Panel Controls .....	8-11 thru 8-13
Seat Controls .....	8-14 thru 8-16
Seat Belts and Child Restraints .....	8-16, 8-17
Instrument Panels .....	8-18 thru 8-33
<b>SECTION 9: CARE AND MAINTENANCE</b>	
Upholstery & Fabrics .....	9-2
Engine Access .....	9-4
Jacking and Tire Changing .....	9-6
Recovery Towing .....	9-8
Rear Suspension (Tag Axle) - Model 37RQ .....	9-10
<b>SECTION 10: SEASONAL STORAGE AND PREPARATION</b>	
Winterizing .....	10-1
Removal From Storage .....	10-3
Water System Drain Valve Locations .....	10-5, 10-6



# SECTION O: INTRODUCTION

Congratulations on the purchase of your new motor home, which has been carefully designed, engineered and quality built by Winnebago Industries, Inc., the company that founded the motor home industry.

## **Operator's Manual**

Please read this operator's manual thoroughly. It was prepared in order to provide you with information necessary to properly and safely operate your new motor home.

This manual describes those instruments, controls and instructions which are unique to Winnebago and Itasca motor homes. For information regarding all other equipment, controls and instructions not described herein, we urge you to read the Vehicle Chassis Manual and the equipment manufacturer's information provided in your Owner Information Packet. (See "Vehicle Chassis Manual" and "Owner Information Packet" below.)

This manual should be kept in the vehicle at all times for personal reference. The operator's manual, owner information packet and vehicle chassis manual are to be considered permanent components of this vehicle. They should remain in the vehicle when sold to provide the next owner with important safety, operating and maintenance information.

**NOTE:** The descriptions, illustrations, and specifications in this manual were correct at the time of printing. We reserve the right to change specifications or design without notice, and without incurring obligation to install the same on products previously manufactured.

## **Vehicle Chassis Manual**

Throughout this manual, frequent reference is made to the vehicle chassis manual. The chassis manual is the operator's manual provided by the manufacturer of the chassis on which this motor home is built. (i.e. Chevrolet, Ford, etc.) Consult the chassis manual for operating safety and maintenance instructions pertaining to the chassis section of the motor home.

## **Owner Information Packet**

Your Owner Information Packet is the large, vinyl, zip-lock pouch which was presented to you when you took delivery of your motor home. It contains information supplied by manufacturers of individual appliances and equipment installed in your motor home.

Consult this information regarding the operation and care of appliances, accessories and special equipment.

## **Options and Equipment**

Since Winnebago and Itasca motor homes are available in many models and sizes, accessories and components may differ between models. Therefore, some equipment described in this manual may not apply to your vehicle.

## **Before Driving**

Before entering the drivers seat, always check around your vehicle in all directions to assure that you have proper clearance in order to avoid minor accidents. When backing up, be positive there is nothing behind your vehicle. As an extra precaution, have a passenger check the area around your vehicle as you

maneuver out of a difficult parking space.

Even though your motor home has been equipped with automotive features such as power steering and power brakes, driving a motor home requires a somewhat different handling technique than driving an automobile. When driving your motor home, always remember that the weight, length, width and height are greater than that of an automobile. A motor home requires greater stopping distance, more parking space, more maneuvering space and more acceleration time when passing other vehicles than does an automobile.

Always be aware of the dimensions of your motor home. Tunnels, low hanging canopies and signs in service stations and restaurants can cause clearance problems. Keep in mind the added height of any options on the roof such as air conditioner units, TV antennas or luggage boxes. Also, remember that certain bridges, old ones in particular, may not accept the weight of your motor home. Always observe any posted weight limits.

When planning a trip to another state, write to the Chamber of Commerce of the state capital for information on state laws pertaining to RV's.

Remember: Always use your seat belt and instruct your passengers to do so as well. Frequent rest stops while traveling are advised to relieve stress on the driver, passengers and the vehicle.

#### **Service and Assistance**

Your dealer will be glad to provide any additional information you need, as well as answer any questions you might have about operating the equipment in your motor home. When it comes to service, remember that your dealer knows your vehicle best and is interested in your satisfaction. Your dealer will provide quality maintenance and any other assistance that you may require during your ownership of the vehicle.

#### **Warranty**

Your new vehicle is covered by a factory warranty against defects in material and workmanship. This warranty should be validated immediately and returned to the factory by your dealer. For additional information, see your "New Vehicle Limited Warranty" folder included with this vehicle.

#### **Winnebago-Itasca Travelers (W.I.T.)**

The W.I.T. Club was formed to extend convenience services, monthly communications, fun and fellowship to Winnebago and Itasca motor home owners. Services include special rates at KOA Campgrounds, special RV insurance rates, travel routing, mail forwarding and more. Activities include national, regional, state and local rallies, where you can meet new friends who will soon become old friends. And we even offer a directory to help you keep in touch with those friends.

If you have not received information within 30 days after purchasing your motor home, please contact W.I.T. by calling (515) 582-6874, or you can write to:

Winnebago-Itasca Travelers Club  
P.O. Box 268  
Forest City, Iowa 50436



## EXTERIOR FEATURE IDENTIFICATION - C-Body Motor Homes

Vehicle shown for illustration purposes only. Actual locations of features depends on model and option combinations.

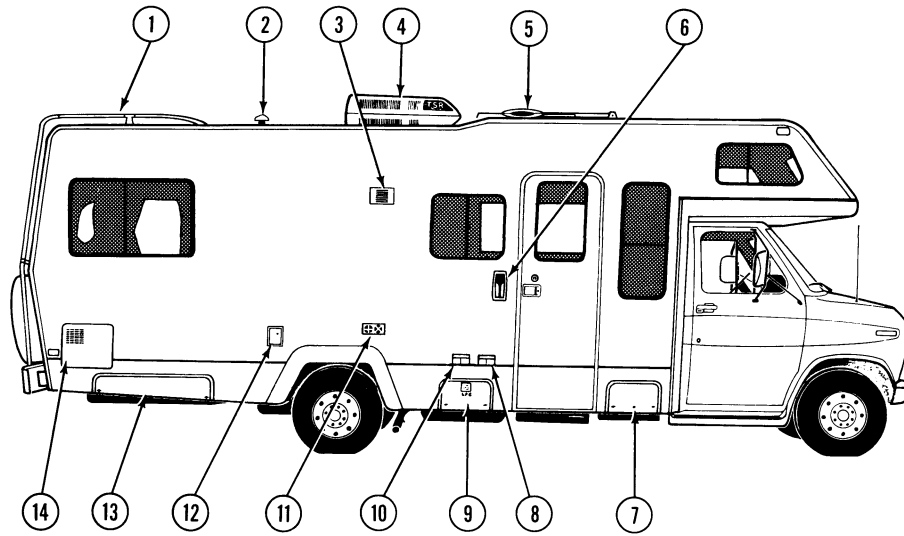

- 1. Roof Rack & Ladder\*
- 2. Plumbing Vent
- 3. Range Hood Vent
- 4. Roof Air Conditioner\*
- 5. TV Antenna\*

- 6. Assist Handle/Porch Light
- 7. Auxiliary Battery Compartment
- 8. 110-Volt Receptacle
- 9. LP Gas Tank Access
- 10. Cable TV Connection\*

- 11. Furnace Intake/Exhaust
- 12. Water Tank Fill Access
- 13. Storage Compartment
- 14. Water Heater Access

\* Optional

## EXTERIOR FEATURE IDENTIFICATION - C-Body Motor Homes (Cont.)

Vehicle shown for illustration purposes only. Actual locations of features depends on model and option combinations.

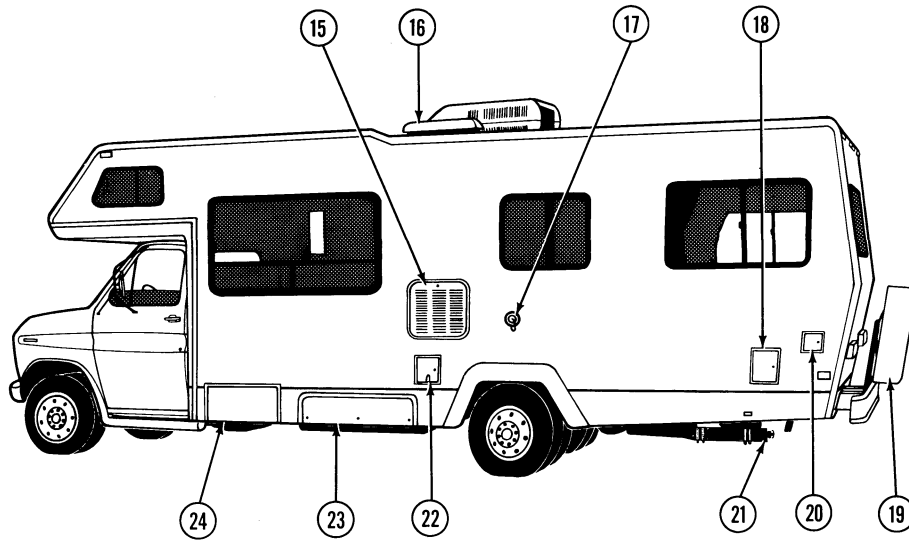

- 15. Refrigerator Access
- 16. Refrigerator Vent
- 17. City Water Connection
- 18. Fuel Fill Access

- 19. Spare Tire Storage
- 20. Waste Drain Hose Storage
- 21. Waste Drain Valve(s)
- 22. Utility Cord Compartment

- 23. Storage Compartment
- 24. Auxiliary Generator Compartment\*

\* Optional

## EXTERIOR FEATURE IDENTIFICATION - A-Body Motor Homes

Vehicle shown for illustration purposes only. Actual locations of features depends on model and option combinations.

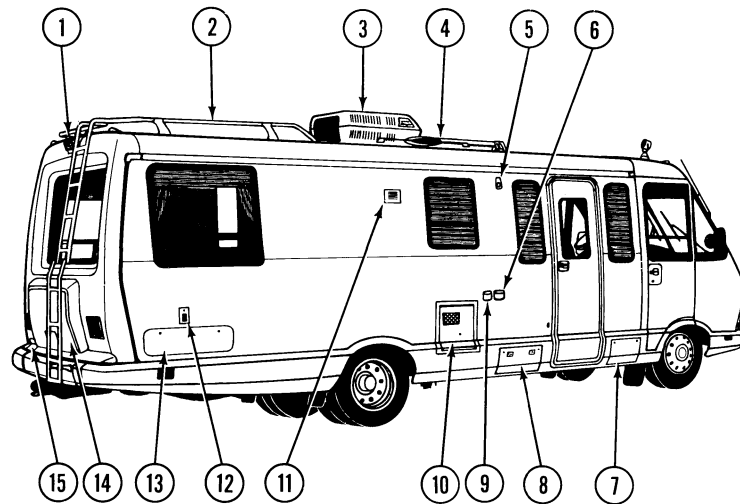

- |                          |                         |                                |
|--------------------------|-------------------------|--------------------------------|
| 1. Rear Monitor Camera*  | 6. 110-Volt Receptacle  | 11. Range Hood Vent            |
| 2. Roof Rack & Ladder*   | 7. Storage Compartment  | 12. Water Tank Fill Access     |
| 3. Roof Air Conditioner* | 8. LP Gas Tank Access   | 13. Storage Compartment        |
| 4. TV Antenna*           | 9. Cable TV Connection* | 14. Spare Tire Storage (Trunk) |
| 5. Porch Light           | 10. Water Heater Access | 15. Waste Drain Hose Storage§  |

\* Optional

§ Located on left sidewall on some models.

## EXTERIOR FEATURE IDENTIFICATION - A-Body Motor Homes (Cont.)

Vehicle shown for illustration purposes only. Actual locations of features depends on model and option combinations.

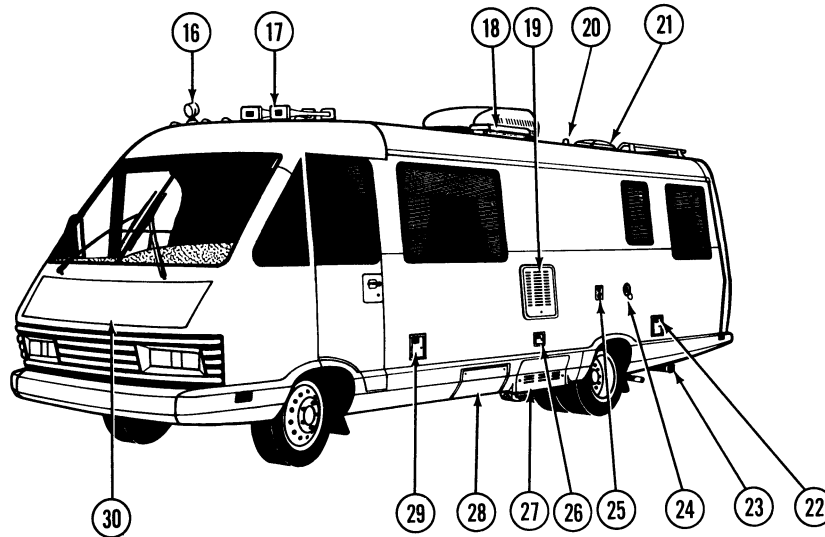

- 16. Remote Flood/Spot Light\*
- 17. Air Horns\*
- 18. Refrigerator Vent
- 19. Refrigerator Access
- 20. Plumbing Vent

- 21. Roof Vent/Skylight
- 22. Main Fuel Fill\*
- 23. Sewage Drain Valves
- 24. City Water Connection
- 25. Furnace Intake/Exhaust

- 26. Utility Cord Compartment
- 27. Auxiliary Generator Access\*
- 28. Storage Compartment
- 29. Auxiliary Fuel Fill
- 30. Hood

\* Optional



# SECTION 1:

## SAFETY PRECAUTIONS

Read and understand all instructions and precautions in this manual before operating your new motor home. The symbol **WARNING** is used throughout the manual to alert you to precautions that involve your personal safety. Read and follow them carefully. Listed are some safety precautions that must be adhered to. These precautions as well as others that involve damage to equipment are also listed in the appropriate areas in this manual.

### General Warnings

- Only seats equipped with seat belts are to be occupied while the vehicle is in motion.
- Make sure all passengers have seat belts fastened in a low and snug position so the force exerted by the belt in a collision will be spread across the strong hip area.
- Never allow passengers to stand or kneel on seats while the vehicle is in motion.
- Sleeping facilities are not to be utilized while vehicle is in motion.
- Examine the escape window and be familiar with its operation, but do not use except in an emergency.

- The fire extinguisher should be inspected monthly for proper charge and operating condition. This should also be done before beginning a vacation or any extended trip.

### Driving

- Do not attempt to adjust the driver's seat while the vehicle is in motion.
- Do not adjust tilt steering in a moving vehicle.
- Do not operate the cruise control on icy or extremely wet roads, winding roads, in heavy traffic or in any other traffic situation where a constant speed cannot be maintained.
- Use care when accelerating or downshifting on a slippery surface. Abrupt speed changes can cause skidding and loss of control.
- Driving through water deep enough to wet the brakes may affect stopping distance or cause the vehicle to pull to one side. Check brake operation in a safe area to be sure they have not been affected. Never operate any vehicle if a difference in braking efficiency is noticeable.
- Adverse weather conditions and extremes in terrain may affect handling and/or performance of your vehicle. Refer to your chassis manual for related information.

## Fuel & LP Gas

- All pilot lights must be extinguished and appliances turned off while refilling the fuel tank or LP tank and before traveling.
- Avoid inhaling exhaust gases produced by burned gasoline, diesel fuel or LP gas in items such as the range, chassis engine, generator engine, refrigerator, furnace and water heater. They contain carbon monoxide, which by itself is an odorless, colorless and poisonous gas.
- Do not bring or store LP gas containers, gasoline or other flammable liquids inside the vehicle because a fire or explosion may result. LP gas containers are equipped with safety valves which relieve excessive pressure by discharging gas to the atmosphere.
- Do not alter the LP gas system at any time or in any way.
- Do not fill LP container(s) above 80 percent of capacity. Overfilling the LP gas container can result in uncontrolled gas flow which can cause fire or explosion. A properly filled container will contain approximately 80 percent of its volume as liquid LP gas.
- Never use an open flame to test for LP gas leaks. Replace all protective covers and caps on LP system after filling. Make sure valve is closed and door latched securely.
- Never connect natural gas to the LP gas system.
- When lighting range burners do not turn burner controls to "On" and allow gas to escape before lighting match.
- Portable fuel-burning equipment, including wood and charcoal grills and stoves, shall not be used inside the recreational vehicle. The use of this equipment inside the recreational vehicle may cause fires or asphyxiation.
- LP gas regulators must always be installed with the diaphragm vent facing downward. Regulators that are not in compartments have been equipped with a protective cover. Make sure that the regulator vent faces downward and that cover is kept in place to minimize vent blockage which could result in excessive gas pressure causing fire or explosion.



The above warning label has been located in the cooking area to remind you to provide an adequate supply of fresh air for combustion. Unlike homes, the oxygen supply is limited due to the size of a recreational vehicle. Proper ventilation when using cooking appliances will avoid dangers of asphyxiation. It is especially important that cooking appliances not be used for comfort heating as the danger of asphyxiation is greater when the appliance is used for long periods of time.

- The following label has been placed in the vehicle near the range area:

**IF YOU SMELL GAS:**

1. Extinguish any open flames, pilot lights and all smoking materials.
2. Do not touch electrical switches.
3. Shut off the gas supply at the tank valve(s) or gas supply connection.
4. Open doors and other ventilating openings.
5. Leave the area until odor clears.
6. Have the gas system checked and leakage source corrected before using again.

**Electrical**

- Careless handling of electrical components can be fatal. Never touch or use electrical components or appliances while feet are bare, while hands are wet, or while standing in water or on wet ground.
- Improper grounding of the vehicle can cause personal injury. Do not plug the utility power cord into an outlet which is not grounded and do not adapt the plug to connect to a receptacle for which it is not designed.
- Do not attach an extension cord to the utility power cord.
- Be sure that all electrical appliances to be used contain 3-prong plugs for proper grounding.

- Avoid overloading electrical circuits. Replace fuses or circuit breakers with those of the same size and amperage rating only. Never use a higher rated fuse or breaker.
- Use caution when handling or working near electrical storage batteries. Always remove jewelry and wear protective clothing and eye covering. Avoid creating sparks.

**Loading**

- Store or secure all loose items inside the motor home before traveling.
- Be aware of GVWR, GAWR and individual load limit on each tire or set of duals. (See "Loading the Motor Home", Section 7.)
- Never load the motor home in excess of the gross vehicle weight rating or the gross axle weight rating for either axle.

**Maintenance**

- Do not remove the radiator cap while engine and radiator are still hot. Always check coolant level visually at the see through coolant reservoir.
- Never get beneath a vehicle that is held up by the jack only.
- Do not mix different construction types of tires on the vehicle such as radial, bias or belted tires, as vehicle handling may be affected. Replace tires with exact size, type and load range.

- Do not attempt to start the vehicle by hot wiring.

## CARBON MONOXIDE WARNING

### FORMALDEHYDE INFORMATION

#### WARNING

Some components in this vehicle contain formaldehyde based adhesives which may release formaldehyde fumes into the air for an unknown period of time until total dissipation occurs. Individuals who are allergic to formaldehyde gas fumes may experience irritation to eyes, ears, nose and throat. Reaction in infants may be more severe. Although long range effects are not well understood, testing to date has not revealed any serious health effects in humans at the level of emission from these products.

#### IMPORTANT

To aid in dissipation, ventilate the vehicle by opening all windows and circulating the air with a fan.

For further information or assistance in proper elimination of formaldehyde fumes, contact your dealer.

#### WARNING

Avoid inhaling exhaust gases, as they contain carbon monoxide, which is a colorless, odorless and poisonous gas.

If you suspect that exhaust fumes are entering the passenger compartment, have the cause determined and corrected as soon as possible. If you must drive under these conditions, drive only with **ALL WINDOWS FULLY OPENED**.

The best protection against carbon monoxide entry into the vehicle body is a properly maintained engine exhaust and ventilation system. It is recommended that the exhaust system and body be inspected by a qualified motor home service center.

- Each time the vehicle is raised for an oil change.
- Whenever a change in the sound of the exhaust system is noticed.
- Whenever the exhaust system, underbody or rear of the vehicle is damaged.

To allow proper operation of the vehicle's ventilation system, keep front ventilation inlet grill clear of snow, leaves or other obstructions at all times.

**DO NOT OCCUPY A PARKED VEHICLE WITH ENGINE RUNNING FOR AN EXTENDED PERIOD.**

Do not run engine in confined areas, such as a garage, except to move vehicle in or out of area. When vehicle is stopped in an **UNCONFINED** area with the engine running for any more than a

short period, adjust heating or cooling system to force outside air into the vehicle as follows:

1. Set fan to medium or high speed and vent control to "air".
2. On vehicles equipped with air conditioning, set fan to medium or high speed and set control to obtain maximum vent air.

Doors and rear windows should be closed while driving to avoid drawing dangerous exhaust gases into the vehicle.

## EMERGENCY EXITS

### Emergency Exit Window

Your motor home is equipped with a one piece stationary window at the rear or side of the vehicle which functions as an escape exit in an emergency situation. The glass is installed with a rubber extrusion and is removed by pulling on the red plastic loop located at the bottom of the windows, until the rubber cord is completely removed. This allows the window to be pushed out. Instructions for removal are also located on a label on the glass for quick reference and for passengers who may not be familiar with the exit. Be sure this label is never removed or destroyed.

### CAUTION

Use the window for emergency exit only. **Do not** test for proper operation.

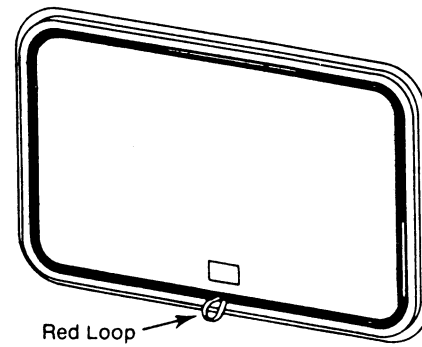

If the cord is released by accident, but the glass remains in place, the cord can be replaced using a blunt instrument, preferably one made of plastic. We suggest you contact a Winnebago or Itasca dealer for assistance.

### WARNING

Use care when exiting emergency window, as broken glass may be present in the exit area.

### Use of Slider Windows as Emergency Exits

Most single and double slider windows along the side of the motor home can also be used as emergency exits, should the need arise. To use the windows as exits, slide the window open, then strike the screen near one corner to loosen it and push out.

**FIRE EXTINGUISHER**

The dry chemical fire extinguisher is conveniently located near the entrance door area on both A-body and C-body motor homes.

It is highly recommended that you become thoroughly familiar with the operating procedure displayed on the side of the extinguisher. A fire extinguisher must be inspected at least once a month in accordance with National Fire Protection Association (NFPA) recommendations as stated on the label.

Before departing on a vacation or any extended trip, it would be most beneficial to instruct all passengers in the use of all safety devices contained within the motor home including the location and operation of the fire extinguisher.

## SECTION 2: LP GAS SYSTEM

(See also Safety Precautions, Section 1 of this manual.)

### LP GAS SUPPLY

The LP Gas system supplies fuel for the range, water heater, furnace and refrigerator (while in gas mode). When used and handled properly, this system is safe and economical and provides modern living conveniences wherever you travel.

### SAFE USE OF THE LP GAS SYSTEM

- Exercise caution at all times. Become familiar with the distinctive odor of LP gas. If a leak is suspected, turn off the supply valve immediately. Have the LP gas system checked by your dealer or a qualified LP gas service center.
- Be sure that the LP gas leak detector/alarm is operating properly. Perform the recommended tests listed in this section daily. Refer to the manufacturer's information in your Owner Information Packet for further instructions.
- Do not tamper with the LP gas piping system, pressure regulator or gas appliances. Service and maintenance of LP gas system components should be performed only by your dealer or a qualified LP gas service center.
- Never attempt to connect natural gas to the LP gas system.
- Have the entire LP gas system inspected for possible leaks and missing or damaged parts at each tank filling. Also inspect before and after each trip, and any time trouble is suspected.
- Turn the LP supply valve off before traveling and when not using the LP gas system. Never operate the vehicle with LP gas appliances in use or with the LP supply valve open.

- Test the LP system with the leak gauge each time the supply valve is opened. Test daily during periods of extended use. (See "Leak Gauge" in this section.)
- Never use a wrench to tighten the tank supply valve. It is designed to close leak-tight by hand. If a wrench is required to completely close the valve, it is defective and must be replaced.
- Never allow the tank to be filled above the 80 percent level indicated by the flow of liquid gas out of the overflow valve or by the automatic stop-fill device.
- Be sure appliance and outside vents are open and free from obstruction when using the LP Gas system.
- Never attach a lock or any device requiring a key to the LP tank compartment door. According to standards set for recreation vehicles, the LP supply valve must be readily accessible in an emergency.
- Exercise caution when drilling holes or attaching objects to the walls. Gas lines and electrical wiring could be seriously damaged and present an extreme safety hazard.

### How LP Gas Works

LP (Liquified Petroleum) Gas is a true gas compressed into liquid form for easy transportation and storage. It is known by several names such as tank gas, bottled gas or simply as butane or propane, which are the two types of LP available.

LP is used by appliances in vapor form only, but is stored in the tank as a liquid under very high pressure. As the liquid gas is released, it reverts back to a vapor and expands to many times it's compressed volume. It passes through a regulator which

reduces the pressure to under 1 p.s.i. to be used by the appliances. This is how so much fuel is available from a relatively small container.

### Selecting Fuel Types

Butane burns hotter than propane, but will not develop a usable gas vapor at temperatures lower than 32° F. Propane, on the other hand, does not burn as hot but will convert to usable gas at temperatures down to -44° F. For this reason, propane is popular in cold climates, while butane and propane/butane mixtures are used most widely in milder climates.

### IMPORTANT

Most LP dealers normally handle only the type of LP gas in their climate and area. If you anticipate filling your tank in one of the warmer states prior to traveling to a colder area, it is advisable to request propane only. Otherwise your LP system may fail to operate if the temperature drops below 32° F.

Each gallon of liquid LP gas contains approximately 92,000 BTU's of heat energy; or putting it another way, each gallon of LP gas produces approximately 36.2 cubic feet of dry gas for cooking, heating, water heating and refrigeration.

To find out how long a gallon of LP gas will last, you should determine the total BTU input on all your LP gas appliances in use. Let's say you have a heater that has a 10,000 BTU input per hour of operation. A gallon of LP gas would last 9.2 hours of continuous operation ( $92,000 \div 10,000 = 9.2$ ). To estimate how long a gallon of LP gas lasts, try to determine what your total daily BTU input is, then divide into 92,000 to arrive at an approximate daily LP gas consumption.

## WARNING

**Test the LP system with the leak detector each time the gas valve at the tank is turned on. Never operate the vehicle with LP gas appliances on or with the LP tank valve open. Never attempt to connect natural gas to the LP gas system.**

### BULK TANK SYSTEM

The storage reservoir for the LP gas system is a horizontally mounted tank which is permanently attached to the vehicle frame. The tank is accessible only from the outside of the vehicle. The tank control valve is located near the top center of the tank, next to the regulator. Before opening the control valve, check to be sure all controls for gas appliances are in the "Off" or "Pilot Off" position. If this step is not performed, LP gas could accumulate inside the motor home creating a fire or explosion hazard.

A float gauge, located near the center of the tank, indicates the liquid level in the tank. It is recommended that the tank be refilled at an authorized LP gas dealership anytime the gauge indicates approximately 10 percent of capacity.



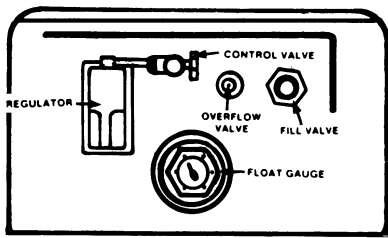

**LP Gas System Controls**

### **Refilling Bulk LP Tank**

There are many LP gas refueling stations located throughout the country. These stations are listed in the telephone directory in the Yellow Pages under "Gas-Liquified Petroleum-Bottled and Bulk".

Since the bulk LP container is permanently mounted to the frame, the motor home must be taken to an LP dealership for filling. Do not attempt to remove the LP tank from the vehicle. The bulk tank is equipped with a fill adapter with both internal and external threads which allows easy filling with any LP filling equipment. The tank is full when liquid LP gas appears at the overflow valve.

**NOTE:** The LP tank is equipped with an automatic 80% stop-fill device.

### **Air in the LP Gas Tank**

Air in LP gas containers must be removed prior to initial filling with LP gas. If the container is not properly purged, air in the container dilutes the LP gas vapor. Appliances then require constant adjustment and pilot lights won't stay lit. This condition could exist for several months until all air is depleted, leaving pure LP gas vapor. Your LP gas dealer is equipped to purge the tank of air prior to filling.

### **TRAVEL WITH LP GAS**

All LP gas appliances must be turned off and the valve on the LP tank closed before traveling for a number of reasons:

**Safety** - Should your vehicle be involved in an accident and a gas supply line broken, LP gas would be free to escape from an open line, creating a fire hazard.

**State Regulations** - Many states are becoming increasingly regulatory concerning use of LP tanks. For example, it is illegal for motor homes to pass through certain tunnels in the nation due to an LP tank aboard. We suggest you always check local regulations of states through which you plan to travel.

## **WARNING**

**Do not alter or remove LP tank gauge at any time.**

## WARNING

DO NOT FILL CONTAINER(S) TO MORE THAN 80 PERCENT OF CAPACITY. Make sure the motor home is level when filling. It is possible to accidentally overfill the tank if the vehicle is unlevel, especially if the fill valve is on the uphill side. Overfilling the LP Gas container can result in uncontrolled gas flow which can cause fire or explosion. A properly filled container will contain approximately 80 percent of its volume as liquid LP Gas.

All pilot lights **must be extinguished** and supply valve closed before refilling LP gas tanks or vehicle fuel tanks.

Because of the extreme flammability of LP gas and its heavier-than-air qualities, **do not** smoke or expose the tank to an open flame while near a refueling area. **Never** use an open flame to test for gas leaks.

Replace all protective covers and caps on LP system after filling.

**Never** fill the LP tank with engine or generator running.

## REGULATOR

The pressure regulator is protected from the elements by a plastic cover which should be left in place at all times. Any removal of the cover and adjustments of the regulator should be done by your dealer or a qualified LP gas dealership.

## WARNING

Inspect the pressure regulator vent hole periodically for blockage. If any obstruction is apparent, have the regulator serviced by your dealer or a qualified LP gas service center.

LP Gas regulators are installed with the diaphragm vent facing downward. Make sure that the regulator vent always faces downward to minimize vent obstruction which could result in excessive pressure, causing a fire or explosion.

Regulator freeze-ups are caused by the presence of moisture in fuel. This moisture will pass through the cylinder valve and into the regulator where it freezes. Fuel producers, tank and bottle manufacturers and LP gas dealers take every precaution to reduce moisture, but sometimes only a fraction of an ounce entering tank can cause problems. To help avoid the possibility of freeze-up, always keep tank control valve closed when not in use, even when tank is empty, to prevent moisture from collecting on the inside.

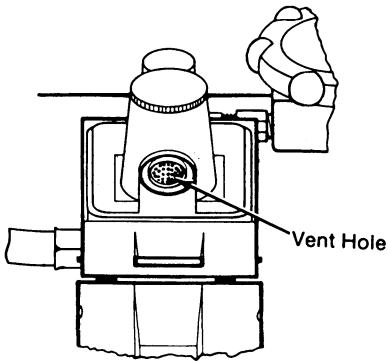

**LPG Pressure Regulator**

If moisture begins causing problems, have your LP gas dealer inject a small amount of dry methyl alcohol in your tank (approximately one ounce to 20 pounds or one pint to 100 gallons) to help guard against regulator freeze-ups.

In very cold weather when a large volume of gas is being used for heat production, it is possible to experience a loss of gas pressure. At first occurrence this problem may appear to be caused by a regulator freeze-up, but is actually caused by failure of the liquid gas to vaporize as fast as it is needed. As the temperature becomes colder, it is increasingly harder for the liquid LP gas to "boil-off" into a vapor. At the same time, the demand for LP to produce heat increases to point where the system cannot maintain production. The only actual solution to this problem is to reduce the consumption of gas where possible. Adjusting the temperature on the gas/electric refrigerator may be a first step. Using less hot water will help as well.

## LP GAS LEAKS

The following label has been placed in the vehicle near the range area. If you smell gas within the vehicle, quickly and carefully perform the procedures listed.

### IF YOU SMELL GAS

1. Extinguish any open flames, pilot lights and all smoking materials.
2. Do not touch electrical switches.
3. Shut off the gas supply at the tank valve(s) or gas supply connection.
4. Open doors and other ventilating openings.
5. Leave the area until odor clears.
6. Have the gas system checked and ~~leakage~~ source corrected before using again.

## LP GAS DETECTOR/ALARM

Your motor home is equipped with an LP gas detector that monitors the air inside the coach for harmful levels of LP gas. If the detector senses a significant amount of LP gas inside the vehicle, it will sound an alarm and automatically shut down the LP gas supply at the tank.

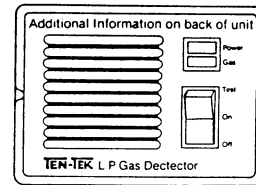

Consult the manufacturer's information provided in your Owner Information Packet for detailed operating, testing and maintenance instructions.

### LP Leak Gauge

Your coach is also equipped with a pressure-drop indicator gauge (manometer) to test for LP gas line leaks. This gauge is located in the refrigerator access compartment on the exterior of the coach and is easily accessible when required. A leak test should be performed before using the LP system in the following situations:

- after storage periods
- each time after opening the main supply valve
- after each LP tank fill
- daily during periods of extended use

Read the following operating instructions and additional information in your Owner Information Packet before conducting the LP gas leak test.

\* Except basic "Campsite" models (without refrigeration). The leak gauge on these models is located in the LP tank compartment.

#### IMPORTANT

This device does not prevent leaks. It detects and indicates leakage only while operated and observed.

If the gauge indicates a leak, recheck to be sure all appliance gas valves have been shut off.

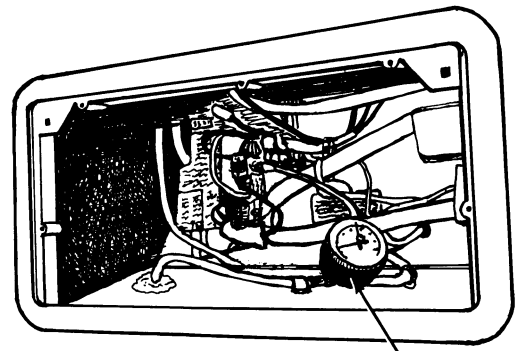

Leak Gauge

(Located in Refrigerator Compartment)

## WARNING

Do not smoke or expose the unit to open flame or extreme heat when conducting an LP gas leak test. Never use an open flame to test for gas leaks.

**Instructions:**

1. Close LP gas tank or cylinder valve(s).
2. Ventilate vehicle. Open doors and windows.
3. Shut off LP gas appliances, including pilots.
4. Now, slowly open LP gas tank or cylinder valve(s).
5. Observe the pressure reading on the gauge as indicated by the black pointer (A) and match this position with the moveable red pointer (B).

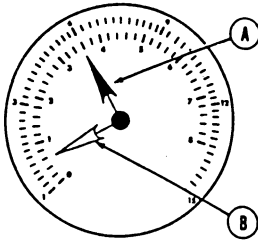

6. Close LP gas tank or cylinder valve(s).
7. With LP gas tank or cylinder valve(s) in a closed position, monitor position of the black pointer for a period of 5 minutes.
  - A. If the black pointer does not move to a lower setting on the gauge, as compared to the red pointer, your system is secure at this time.
  - B. If the black pointer does move to a lower setting on the gauges, as compared to the red pointer, the system has a leak.
8. Conduct a soapy water test at all joints. Tighten if necessary and retest.

**WARNING**

Never use an open flame to test for gas leaks.

Check for leaks with the leak gauge each time the gas valve at the tank is turned and each day during periods of prolonged use. When testing for gas line leaks with a soapy water solution, DO NOT use a detergent containing ammonia or chlorine. These substances may generate a chemical reaction causing corrosion to gas lines resulting in dangerous leak conditions.

9. If test still shows a leak, contact your Winnebago/Itasca dealer.

**WINTER USE OF LP GAS**

Due to vaporization characteristics of LP gas, it is important that the winter camper knows how to most efficiently use the LP system. The vaporization rate of LP gas decreases in a direct relationship to a decrease in temperature. As explained in the "Selecting Fuel Types" section, butane does not vaporize below 32° F, so propane must always be used in cold climates. However, even propane vaporizes at a slower rate as it becomes colder.

The greater the amount of liquid gas in the tank (up to the 80% level) the greater the amount of LP gas vapor generated. The following is an example of the number of BTU's available from an 84 pound tank at 0° F at three levels. As you can see the number of

BTU's decreases as the tank is emptied. Nearly twice as many BTU's are available from a full tank than one that is one fourth full. Therefore, it is to your advantage to keep the tank as full as possible (not to exceed the full level of 80%) during cold weather.

BTU's Available at

Tank Level	0° F.
80%	64,400 BTU's
50%	50,400 BTU's
20%	33,000 BTU's

The following LP Gas Vaporization and Temperature Relationship chart typifies the LP gas loss with a decrease in temperature. The percentage figures are the increase or decrease in the amount of vapor that would be available at 0° F. These figures are applicable to all size LP gas tanks.

TEMPERATURE	PERCENTAGE OF BTU's AVAILABLE AT 0° F.
20° F.	200%
10° F.	150%
-5° F.	75%
-10° F.	50%
-15° F.	25%
-20° F.	12 1/2%
-44° F.	Propane will not vaporize

**WARNING**

Make sure the filling attendant uses the 80% overflow valve when filling the tank. A tank should never be filled above the 80% level to allow for vaporization and liquid expansion.

**WARNING**

LP Gas containers shall not be placed or stored inside the vehicle. LP Gas containers are equipped with safety devices which relieve excessive pressure by discharging gas to the atmosphere.

Do not bring or store LP Gas containers, gasoline or other flammable liquids inside the vehicle because a fire or explosion may result.

# SECTION 3: ELECTRICAL SYSTEMS

(See also Safety Precautions, Section 1 of this manual.)

All Winnebago and Itasca motor homes are equipped with an electrical system consisting of two separate voltages: a 12-volt DC system and a 110-volt AC system. The 12-volt system consists of two internal power sources, while the 110-volt system is operated from an outside power source (or the optional 110-volt generator if equipped) in the unit. All systems operate through a single power converter control center to provide electrical power to the motor home.

## **12-VOLT DC SYSTEM**

The DC voltage system consists of the automotive battery and the 12-volt motor home auxiliary battery(s). The automotive battery is used solely to operate the engine starter and all automotive accessories and controls found on the instrument panel. This includes the horn, speed control, all exterior lights, radio, windshield wipers, electric entrance step, rear auto heater fan, etc.

The auxiliary battery(s) supplies current to all 12-volt equipment located in the living area of the motor home. This includes: interior lights, range exhaust fan, furnace fan, water pump, water level and holding tank gauges, 110-volt generator starting, refrigerator (when operated in DC mode), bath roof vent fan, ignition on water heater and the rear automotive heater. In addition, the auxiliary battery may be used to start the engine if for some reason the automotive battery is discharged; refer to "Dual Battery Switch" and "Battery Isolator".

## **110-VOLT AC SYSTEM**

The 110-volt system operates from an outside 110-volt utility service such as those at campgrounds, or from the optional 110-volt generator on units so equipped. When the power cord is connected to an outside power source, or when the generator is in operation, the power converter automatically changes a portion of the 110-volt current to 12-volt DC current. All equipment in the motor home that is normally powered by the auxiliary battery is then powered through the converter.

In addition, the following equipment is entirely dependent on the 110-volt generator or outside source: roof air conditioner, refrigerator (when placed in 110-volt mode), microwave/convection oven, ice maker, vacuum cleaner and other 110-volt electrical equipment used at convenience outlets.

## **AUXILIARY 110-VOLT GENERATOR**

Consult the information provided in your Owner Information Packet for instructions on operation, troubleshooting and maintenance.

## **External Power Cord**

The external utility power cord (commonly referred to as a "shoreline") is stored in a compartment located on the left side of the motor home.

## WARNING

**Do not** connect the external power cord to any receptacle **until** you have contacted the owner and/or attendant of the premises to verify proper polarity and grounding.

It is the responsibility of the owner of the electrical receptacle to ensure that the receptacle is properly wired and grounded.

Reverse polarity or improper grounding of the vehicle can cause personal injury or death.

To connect to an external power source, remove the cord from the storage compartment and plug it into a suitable power receptacle.

The small "hatch" provided on the compartment door may be swiveled aside, allowing the door to be closed while the cord is attached to an external source.

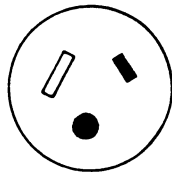

30 Amp Receptacle

The three-wire power cord is designed to ground the electrical system through the receptacle. It is also designed to carry the amperage output of most campground outlets. If the electrical receptacle to be used is designed to mate with the three prongs on the power cord plug, the electrical connection can be expected to carry rated load.

Should an overload on an appliance occur due to an excessive amperage draw, the breaker for the appliance, located on the power converter panel, will trip.

## WARNING

**Do not** plug the power cord into an outlet which is not grounded, or adapt the plug to connect to a receptacle for which it is not designed.

Be sure that all three prongs of the supply cord are properly plugged into the receptacle.

**Do not** connect the power cord to an extension cord.

**Do not** plug the power cord into the generator receptacle while the generator is running.



Most campgrounds are equipped with a fuse or circuit breaker at the receptacle. This protects the park's wiring, as well as the power cord on your vehicle, from electrical damage. If electrical power fails, contact the park attendants and have them check the fuse or breaker for your supply receptacle.

When disconnecting the power cord, neatly replace it in the storage compartment. On motor homes equipped with a 110-volt generator, plug the power cord into the generator receptacle within the compartment.

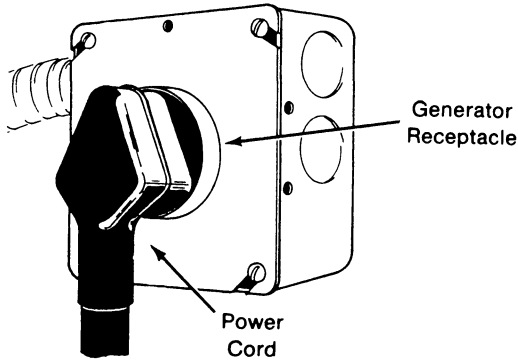

**POWER CONTROL CENTER (Converter)**

The 110-volt to 12-volt power converter is mounted within one of the cabinets or beds, depending on the model. All power to the living area of the motor home (except second optional roof air and 12-volt current to the refrigerator) passes through the control center before going to the individual appliances, lights, outlets,

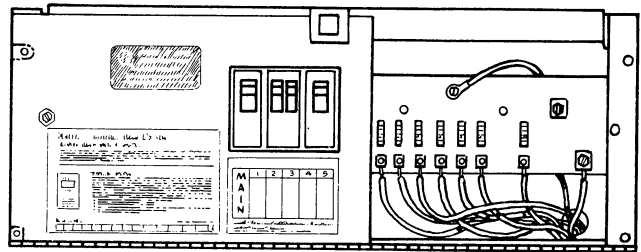

**Power Converter**

etc. Current drawn from the 12-volt battery passes through the control center unchanged, but is routed through a series of fuses to the various functions. While the unit is connected to an external power source, current draws from the 110-volt power source and is routed to the appliances or equipment through the protective circuit breakers in the control system. In addition, a portion of the 110-volt current is changed to 12-volt DC power by the converter. While operating from 110-volt electrical power, all 12 volt equipment (with the exception of the refrigerator in DC mode) is powered through the appropriate fuse circuit within the converter unit, and no power is drawn from the automotive and/or auxiliary battery.

**Charging Section**

A battery charger circuit in the converter recharges the battery while 110-volt external power is connected. The Charging Section will automatically "sense" the condition of the RV battery. If it is below "full charge", the Charging Section will start charging the battery.

If the RV battery has been extremely discharged, it will charge at a relatively high amperage rate. If battery is only slightly discharged, it will be charged at a lower amperage rate. The rate of charge will decrease as the battery reaches "full charge". After battery reaches "full charge", the Charging Section will drop back to "maintenance" level. Active charging will not resume until battery again falls below "full charge". If your storage battery does not charge as described above, it is possible the battery is defective.

#### **Thermal Breaker**

A protective Thermal Breaker will "break" the 110-volt AC power to the converter section of Power Center if the power converter becomes overheated from operating above its maximum limit for an extended period of time or by obstruction of ventilation to unit.

**NOTE:** Power converter section will automatically switch 12-volt lights and motors to battery in this event.

In either case, the Thermal Breaker will reset itself after a period of time, and the lights and motors will again resume operation from power converter section. If the breaker trips again shortly after reset, take immediate steps to correct cause of overheating. A portion of RV 12-volt load (lights or motors or both) should be turned off to reduce total load. Also, inspect power converter section to make certain ventilation is not obstructed.

#### **IMPORTANT**

The converter will not change 12-volt DC current to 110-volt AC.

#### **Circuit Breakers**

The breaker panel protects all 110-volt components in the motor home from either an overload on the circuit or a short in the wiring or component itself. When an overload or short develops, the breaker will open preventing any further flow of electricity and, therefore, damage to the system. After shutting off the equipment (example: roof air conditioner) and allowing a brief cooling period, reset the breaker by moving the switch to "Off" then back to "On". If the breaker is continually tripped and no overload is evident, have the system checked for a short in the wiring or the appliances.

#### **Fuse Panel**

The fuse panel protects all 12-volt equipment in the living area of the motor home. When a circuit is overloaded or a short develops in any part of the system, the fuse will burn out and must be replaced before the system can be operated. Shut off all affected lights or equipment and replace the fuse with another of equal size and amperage value.

A label located on the control panel provides the amperage of each fuse and indicates which circuit or appliance each fuse or breaker protects.

## **WARNING**

Do not store anything on or around the power converter, as it requires unrestricted air flow to dissipate generated heat.

## GROUND FAULT CIRCUIT INTERRUPTER

Exterior, bath and galley outlets are connected to a GFCI (Ground Fault Circuit Interrupter), which is an extremely sensitive circuit breaker that will help to protect against severe electrical shock if a ground fault develops. If such a condition occurs, the GFCI will break the circuit by turning off the power to the protected outlet. Should this occur, unplug all the appliances on that circuit and press the reset button on the GFCI equipped outlet.

The GFCI outlet is located on a wall or cabinet in the general vicinity of the Power Control Center (converter). It is typically an outlet in the bath, bedroom or dinette area, depending on the floor plan of the vehicle.

GFCI Outlet

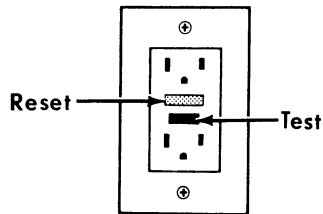

## WARNING

The GFCI will not completely eliminate electrical shock. Small children and persons with heart conditions or other disabilities which make them especially sensitive to electrical shock may still be injured by 110-volt receptacles even though protected by a Ground Fault Interrupter.

NOTE: The galley outlet in Canadian equipped units is not GFCI protected. The GFCI breaker in Canadian vehicles is located on the breaker panel in the Power Control Center (converter).

## BATTERY INFORMATION

### Automotive Battery Access

The automotive batteries for all models are located in the engine compartment.

### Auxiliary (Coach) Battery Access

#### C-Body Vehicles (Except Model 426RT\*)

The auxiliary batteries are located in an exterior battery storage compartment. They are mounted in a slide-out tray for convenient access for periodic inspection or maintenance.

To service or remove the batteries, pull the retainer pin from the tray and slide the tray outward.

\* (The auxiliary battery for model W/IF426RT is located in the engine compartment.)

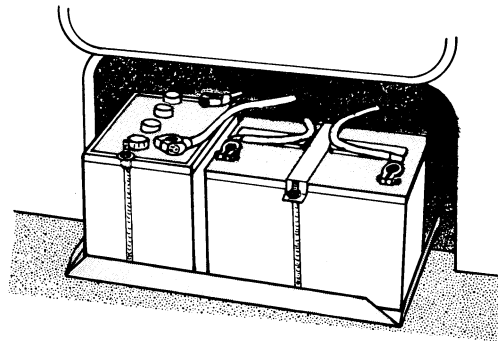

## WARNING

Reinstall the retainer pin when returning the tray to the storage position.

### A-Body Vehicles (Except Elandan & Windcruiser)

These models contain an auxiliary battery compartment accessible from the interior of the coach. To gain access, unfasten the latch at the front of the top entrance step and open the carpeted compartment door upward.

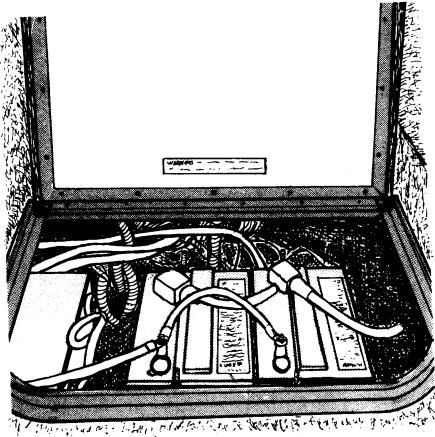

### Elandan & Windcruiser

#### (With Cab Doors)

The auxiliary batteries are located in separate compartments in the pilot and co-pilot door stepwells. Access to either battery is gained by removing a metal cover behind the carpeted plastic stepwell panel. Remove the four screws that retain the stepwell panel, slide the panel up and remove. Next, extract the screws fastening the metal cover to the stepwell and remove the cover. To slide the battery tray out for servicing, pull up on the tray retainer pin and pull tray outward.

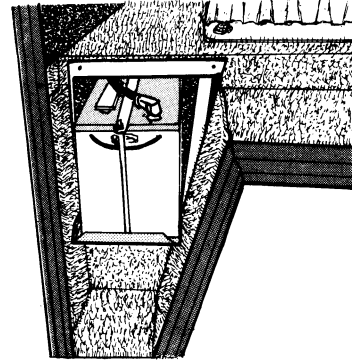

#### (Without Cab Doors)

If your vehicle is not equipped with a passenger cab door, the auxiliary battery compartment on that side of the vehicle is located below the floor directly behind the passenger seat. Remove the access cover on the floor behind the seat to inspect or service the battery. (This also applies to the driver side of the vehicle if not equipped with a driver cab door.)

## Battery Maintenance

A battery is merely a storage reservoir, not a source of electricity. As soon as energy is removed from the battery, it should be replaced by the alternator system. To ensure that the battery will always accept and hold a charge, some minor maintenance practices should be followed.

Make sure that batteries always remain securely clamped in the battery tray and the cable clamps are tight on the terminal posts and free of corrosion. Any corrosion build up on the battery may be neutralized by washing with a solution of baking soda and water and then rinsing with clear water.

### IMPORTANT

Make sure vent caps are on securely to prevent baking soda solution from contaminating the battery electrolyte.

## WARNING

Before removing any battery cables or battery, make sure all 12-volt equipment in the motor home is off and the power cord has been disconnected.

Be sure to replace the battery terminal boot back onto the positive terminal before sliding tray in after servicing. Care must be taken when sliding the battery tray back in, to avoid pinching the extra cable between the tray and the vehicle frame. Should the cable be damaged, a short could result in personal injury or damage to equipment. Replace any damaged cables at once. Always remove jewelry and wear protective clothing and eye covering when checking or handling batteries.

Reinstall the retainer pin when returning the tray to the storage position.

Clean and tighten battery terminals and have the specific gravity checked at least once a year. Every two months, or more often in hot weather, check the battery fluid level. Fill to approximately 3/8 inch above the plates. DO NOT OVERFILL. If fluid is added during freezing weather, the motor home should be

driven several miles to mix water and electrolyte and prevent freezing. Fluid level check may be omitted if equipped with maintenance free batteries.

## WARNING

To prevent wiring damage, it is essential when replacing the cables on the battery, or when using a "booster" battery, that the positive post and the positive cable be attached and the negative post and negative cable be attached. The posts are marked (+) plus and (-) minus. If a "fast charger" is used while battery is in the motor home, disconnect both battery cables before connecting the charger. Never attempt to charge or boost a frozen battery.

### BATTERY CONDITION METER AND SWITCH - Optional

This gauge allows the driver to monitor the state of charge of batteries in the motor home. The battery condition switch is used to select the battery to be monitored. Depress the left side to monitor the automotive battery; the right side to monitor the auxiliary battery.

To obtain an accurate reading:

1. The dual battery switch must be in the neutral position.
2. Both the automotive engine and the auxiliary generator engine must be stopped.
3. An interior light should be turned on to provide a small load which draws off battery surface charge.

### DUAL BATTERY SWITCH A & C-Body Motor Homes (Not Available Diesel Equipped Vehicles or Model 319RB)

The dual battery switch is used to connect the auxiliary battery to the automotive electrical system, allowing it to be recharged by the engine alternator while driving. The momentary position can be used to provide additional starting power from the motor home auxiliary battery, if for some reason the automotive battery is discharged.

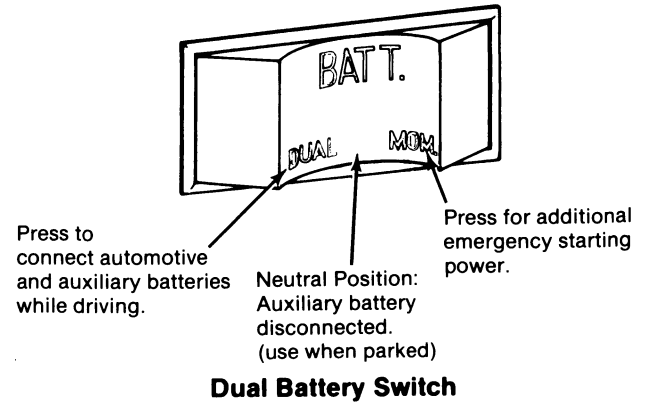

## CAUTION

Damage to the automotive alternator can occur if the 110-volt auxiliary generator is started while both batteries are connected. Never leave the dual battery switch in the dual position while parked as it could allow both batteries to discharge.

## CAUTION

NEVER disconnect the auxiliary batteries while the utility power cord ("shoreline") is plugged into either the generator or an external receptacle. Electronically sensitive equipment, such as TV's and VCR's or high-amperage equipment, such as the refrigerator and electric step, may be damaged if operated while auxiliary batteries are disconnected.

### **AUXILIARY BATTERY DISCONNECT SWITCH - Optional (A Body Motor Homes Only)**

This switch allows you to conveniently disconnect the auxiliary battery during prolonged storage periods without the need for removing a battery cable in the battery compartment. This disconnection reduces the possibility of battery drain by electrical devices (such as clocks) which are energized continuously.

Press the switch momentarily and release to connect or disconnect the battery. The switch is spring-loaded and will return to the neutral position when released. An indicator light located next to the switch will be illuminated while the auxiliary battery is connected to the system.

The auxiliary battery disconnect system is intended to be used to disconnect the auxiliary batteries only while the motor home is not in use, such as long-term or seasonal storage. It should not be used in an attempt to "save" the auxiliary batteries while using the 110 volt system.

#### **If The Auxiliary Batteries Become Discharged**

Since the battery disconnect switch is powered by the auxiliary batteries, the switch cannot be turned ON if auxiliary battery voltage is drained to below 7.5 volts. However, it is possible to "jump start" the switch using the main battery to operate the switch and reconnect the auxiliary batteries. Described below are two different procedures to follow in this event. The procedure you should use depends on the model and equipment installed in your motor home.

#### **A-Body Motor Homes Equipped with Audiovox HCC-1160 and AVX-3000 Radios ONLY: (Except Elandan or Windcruiser with optional electronic instrument panel)**

1. Place the Dual Battery Switch in the Neutral (middle) position.

2. Depress **and hold** the Battery Condition Switch in the MAIN position.
3. Press the Battery Disconnect Switch to the ON position and release.
4. Release the Battery Condition Switch from the MAIN position and press to the AUX position to verify connection of the auxiliary batteries.
5. Start the engine to provide alternator charging.
6. Place the Dual Battery Switch in the DUAL position to charge auxiliary batteries.

NOTE: This procedure is necessary only if the auxiliary batteries are extremely discharged. If the auxiliary batteries fail to reconnect, check the 5A fuses on the top of the relay and replace with 5A fuses if necessary. If the fuses are OK, another problem may exist. See your dealer for assistance.

**A-Body Motor Homes Not Equipped with Audiovox HCC-1160 and AVX-3000 Radios and Elandan and Windcruiser with Electronic Instrument Panel:**

1. Place the transmission in PARK, engage the parking brake and switch the ignition OFF.
2. **Elandan or Windcruiser:** Raise the hood to locate the battery disconnect relay on the circuit breaker panel near the automotive battery.

**Chieftain, Sunflyer, Superchief or Suncruiser:** Open the battery storage compartment and locate the battery disconnect relay on the inner wall of the compartment.

## WARNING

Automotive batteries produce caustic acid, explosive gases and electrical current which may cause burns. It is important that the instructions below are followed **exactly**, or personal injury (particularly to eyes) or property damage may result due to battery acid, or electrical (short circuit) burns.

- NEVER smoke near the battery or expose it to open flame or electrical sparks.
- Wear eye protection or shield your eyes while working near either battery, in case an explosion does occur, NEVER lean over a battery.
- Do not allow battery fluid to contact eyes, skin, clothing, or painted surfaces. Flush any contacted area thoroughly with water immediately. Seek medical help if eyes are affected.
- Remove all metal jewelry to lessen the risk of a short circuit occurring.



3. Use a standard battery "jumper cable" to connect the relay main terminals as shown.
4. Place the Dual Battery Switch in the DUAL position and start the engine to provide alternator charging to batteries.
5. Press the Battery Disconnect Switch to the ON position to connect auxiliary batteries, then release.
6. Disconnect jumper cable and close hood or storage compartment.

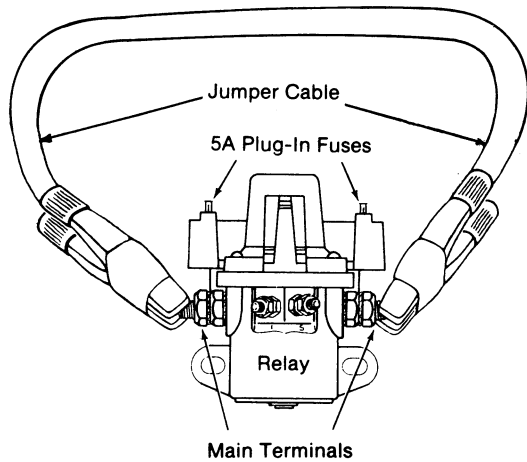

**NOTE:** This procedure is necessary only if the auxiliary batteries are extremely discharged. If the auxiliary batteries fail to reconnect, check the 5A fuses on the top of the relay and replace with 5A fuses if necessary. If the fuses are OK, another problem may exist. See your dealer for assistance.

#### Indicator Light

The indicator light will be illuminated under the following situations regardless of whether or not the system is activated.

1. The vehicle 110 volt system is in use and the coach power converter contains a battery charging section. (All converters used in Winnebago and Itasca motor homes have this feature.)
2. The ignition switch is ON and the Dual Battery Switch is in the DUAL position.

These conditions are common to all battery disconnect systems equipped with an indicator light, but do not affect the operation of the system. However, it could indicate that the auxiliary batteries are connected when they actually are not.

**ALWAYS VERIFY THAT THE AUXILIARY BATTERY SYSTEM IS ACTIVATED** before starting the engine or using the auxiliary generator or external power cord. This can be verified by checking the Battery Condition Meter with the switch in the AUX position (ignition switch OFF) in addition to observing the indicator light.

#### BATTERY ISOLATOR (Diesel Equipped Vehicles)

The battery isolator is designed to connect the auxiliary battery to the automotive electrical system, allowing it to be charged by

the engine alternator while driving. The isolator also prevents coach equipment from drawing power from the automotive (starting) batteries

## **AUXILIARY 110-VOLT GENERATOR (Optional)**

Consult the information provided in your Owner Information Packet for instructions on operation, troubleshooting and maintenance.

### **WARNING**

**Careless handling** of the generator and electrical components can be fatal.

**Never** touch electrical leads or appliances when your hands are wet, when standing in water or on wet ground.

**Do not** attempt to repair the generator yourself. Service should be performed by an authorized service center.

**Do not** plug the power cord into the generator receptacle while the generator is running.

### **Remote Start/Stop Switch**

This switch allows you to start or stop the auxiliary generator from inside the motor home. The switch performs the same function as that of an automotive ignition switch.

To start the generator, press the on switch and hold until the generator engine starts, then release. To stop the generator, simply press the OFF side of the switch.

### **CAUTION**

Damage to the automotive alternator can occur if the 110-volt auxiliary generator is started while both batteries are connected.

### **Generator Hourmeter**

This meter registers the total number of hours that the generator has been operated. Refer to the hourmeter often to determine when periodic maintenance is due and to record services which have been performed.

## Operation Warnings and Cautions

### **WARNING**

The exhaust of all internal combustion engines contains carbon monoxide (CO). This gas is colorless, odorless, tasteless, lighter than air and poisonous. The exhaust systems of both your motor home engine and your generator engine have been installed with your safety in mind. However, certain precautions must be taken in their use to protect you from conditions beyond the control of the manufacturer.

1. **Do not** simultaneously operate the generator engine and a ventilator which could draw air into the vehicle, resulting in the entry of exhaust gases.
2. **Do not** open windows or ventilators on the end or side of the vehicle where exhaust of the generator is located.
3. **When parked**, orient the vehicle so that the wind will carry the exhaust away from the vehicle. Also, note the position of other vehicles.
4. **Do not** operate the generator engine when parked so that vegetation, snow, buildings, vehicles, or any other object can deflect the exhaust under or into the vehicle.



## SECTION 4: WATER SYSTEM

The water system in your motor home may be supplied from either of two sources; a water tank located within the motor home, or from an outside city or campground water source. The water from either source supplies the kitchen sink, shower, bathroom vanity, toilet and water heater.

### INTERNAL WATER SYSTEM

#### Filling Procedure

The tank fill access is located on an exterior sidewall of the vehicle. The tank may be filled with a hose, or when city water or a hydrant is not available, a bucket and funnel may be used.

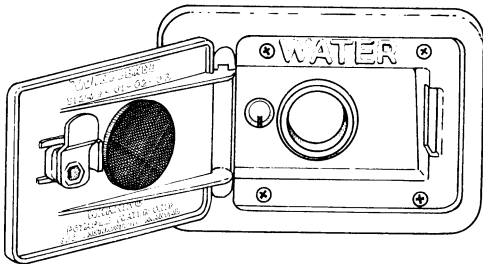

Water Tank Fill

#### Water Pump

Pressure for the water system is supplied by a water system demand pump which is fully automatic after initial priming. When a faucet is opened, the pump instantly begins operation to provide a constant flow from the tank. As soon as the faucet is closed, the pump automatically shuts off.

#### Water Pump Switch

The water pump switch is located on the right side of the optional water/holding tank monitor panel. If your vehicle is not equipped with the monitor panel, the switch will be located on a lower cabinet, the panel below a bed or on the wardrobe wall panel, depending upon model. While the switch is in the "On" position, the pump will automatically supply water pressure as it is needed. It is recommended that the pump switch be turned off whenever you are away from the vehicle or not using the water system. A slow leak in a faucet could drain the water system, as well as the coach battery.

#### Initial Start-up

1. Make sure that all water drain valves are closed, including water heater. (Refer to WINTERIZING in Section 10.)
2. Turn water pump switch to "Off" position. Open water fill spout and fill with hose or suitable container.
3. Open all faucets, hot and cold.
4. Turn on pump switch.

5. Close each faucet as it begins to deliver a steady stream of water. (Close cold water first). Leave hot water faucets on until they also deliver a steady stream of water. This will ensure that the water heater is filled with water.
6. Check to be sure pump stops soon after all faucets have been closed.
7. Pump is now ready for automatic operation. Pump will start when a faucet is opened and stop when the faucet is closed.

#### **INSTRUCTIONS FOR DISINFECTION OF POTABLE WATER SYSTEMS ON RECREATION VEHICLES**

**(As approved by the U.S. Public Health Service)**

To assure complete disinfection of your potable water system, it is recommended that the following procedures be followed on a new system, one that has not been used for a period of time, or one that may have become contaminated. This procedure is also recommended before long periods of storage such as over winter.

1. Prepare a chlorine solution using 1 gallon of water and 1/4 cup of household bleach (sodium hypochlorite solution). With tank empty, pour chlorine solution into the tank. Use 1 gallon solution for each 15 gallons of tank capacity. This procedure will result in a residual chlorine concentration of 50 ppm in the water system. If a 100 ppm concentration is required as discussed in item 3, use 1/2 cup of household bleach with 1 gallon of water to prepare the chlorine solution. One gallon of the solution should be used for each 15 gallons of tank capacity.

2. Complete filling of tank with potable water. Open each faucet and run the water until a distinct odor of chlorine can be detected in the water discharged. Do not forget the hot water taps.
3. Allow the system to stand for at least 4 hours when disinfecting with 50 ppm residual chlorine. If a shorter time period is desired, then a 100 ppm chlorine concentration should be permitted to stand in the system for at least 1 hour.
4. Drain and flush with potable water.

### **WARNING**

Chlorine is poisonous - recap bottle and clean utensils after use.

Never use automotive type anti-freeze in your potable water system as it is poisonous.

#### **EXTERNAL WATER SUPPLY - OPERATION** **To operate from an external source**

1. Turn the demand pump switch to OFF.

2. Attach a hose from the external water source to the city water connection on your vehicle. This connection is located on the left side of the vehicle.

City Water  
Connection

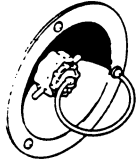

3. Turn on the external water source.

When connected to an outside source of water, the water bypasses the demand pump and storage tank and supplies pressure directly to individual faucets and toilet. A check valve built into the pump prevents water from entering the pump and filling the storage tank.

**To disconnect from the external source:**

1. Turn the external source off.
2. Open a faucet inside the vehicle to relieve line pressure.
3. Disconnect the hose from the vehicle and replace the cap on the connection.





## SECTION 5: DRAINAGE SYSTEM

The drainage system is self-contained, allowing use of the toilet, sinks, or shower even in areas where hook-up is not available. The drainage system may have one or more holding tanks depending on model and floor plan. When the unit is equipped with more than one tank, one accepts sewage water from the toilet and lavatory, and the remaining tank(s) receive waste water from the galley and shower. The holding tanks are dumped through a common outlet located on the left side of the vehicle. This is generally located to the rear of the dual wheels.

**NOTE:** On Superchief and Suncruiser models the sewage dump outlet is located inside a compartment on the rear driver side of the vehicle. A shelf is provided inside the compartment for stowing the drain hose. The hose may also be left attached to the dump valve inside of the compartment.

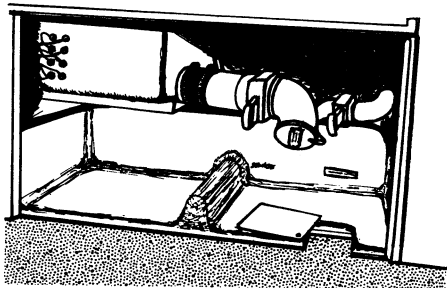

SEWAGE DUMP VALVES  
(Superchief and Suncruiser)

A door at the floor of the compartment slides aside to allow the hose to be routed out of the compartment during use.

### DUMPING HOLDING TANKS

1. Remove drain hose from rear bumper or exterior storage compartment.
2. Remove dust cap from drain and connect drain hose. Be sure it is firmly attached.
3. Place the other end of sewer hose into disposal opening.
4. Unlock the drain valve by turning the handle 1/4 turn to the left (counter-clockwise) and open the valve with a quick pull. **OPEN ONE VALVE AT A TIME.** Move hose gently about to dislodge any waste and to ensure complete drainage.

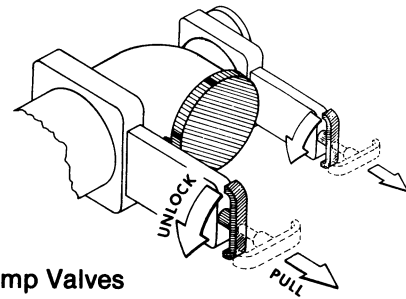

Sewage Dump Valves

5. Close sewage valve and open waste water valve with a quick pull. Make sure there are no sags in the hose during drainage. Close valve handle and rotate to the lock position as soon as tank is empty.
6. After both tanks have been drained, run several gallons of water into the sewage tank through the toilet. Then open sewage dump valve and drain the tank again. Close valve and lock in place. Securely replace dust cap.
7. It is advisable to add an odor control chemical to the sewage holding tank. These chemicals are available at most R.V. stores.
8. Rinse sewer hose thoroughly with water and stow.

### **USE OF IN-PARK SEWER SYSTEM**

When using a sewer hook-up while parked, such as in a trailer park, keep the dump valves closed; and open only when preparing to leave or when the tank becomes full. This keeps the solids in suspension, allowing them to be carried out with the rush of liquids when the dump valve is opened. If the valve is left open, the liquids will run off leaving solids in the tank. Should this accidentally happen, disconnect the hose, fill the tank about half full with water, and drive a few miles to dislodge the solids. A few starts and stops will aid in this process. Then reconnect the hose and drain in the normal manner.

## SECTION 6: INTERIOR FEATURES AND EQUIPMENT

(See also Safety Precautions, Section 1 of this manual.)

### IMPORTANT

Since Winnebago and Itasca motor homes are available in a wide variety of models and floor plans, some items described may be optional or unavailable on certain models and, therefore, may not apply to your vehicle.

### WARNING

Sleeping facilities are not to be utilized while vehicle is in motion.

Latch the pull-down bunk securely in position when the vehicle is in motion or when the bunk is not in use. Do not use for storage.

### FRONT PULL-DOWN BUNK (A-Body)

#### To Lower:

1. Recline the driver and passenger front seats.
2. Pull the front privacy curtain ahead to increase side clearance.

3. Be sure sunvisors are against the windshield.
4. Release the latches at the rear of the bunk. (Push up center button of latch to unlock latch handle.)
5. Using the strap handle, pull the bunk downward into position.

#### To Raise:

1. Remove any items from the bunk which could contact the ceiling or otherwise prevent the bunk from fully retracting.
2. Lift the bunk upward into the stored position and refasten the latches.

### OVERHEAD BUNK (C-Body)

The overhead bunk is located above the driver's compartment. While in the stored position, it allows easy access to the front seats from the living area of the motor home. It conveniently and easily converts to a full-size bed as described below.

1. To convert to a bed, grasp the loop on the top section of the mattress and carefully unfold to cover the driver's compartment.
2. To stow the bed while not in use, fold the rear mattress section forward onto the front section.

## **COUCH/BED CONVERSIONS**

### **Continental Bed**

#### **To Convert Couch to Bed:**

1. Remove the backrest cushions from the couch.
2. Grasp the front edge of the couch and pull upward and outward from the wall at the same time.
3. Lift the front edge of the seat cushion and unfold it toward the wall until it lies flat, forming a sleeping surface.

#### **To Revert to Couch:**

1. Fold the mattress forward from the wall to return the seat cushions upright.
2. Pull the front of the couch upward and push in toward the wall at the same time until fully seated against the wall.
3. Place the backrest cushions in their original locations.

### **Presto Bed/Shrock Bed**

#### **To Convert Couch to Bed:**

Pull the front edge of the couch seat upward and outward from the wall while gently pushing downward on the backrest until the cushions lay flat. The bed is now ready for use.

#### **To Revert to Couch:**

Push the front edge of the seat toward the wall while lifting upward on the backrest until the couch is fully seated against the wall.

### **DINETTE/BED CONVERSION**

#### **To Convert Dinette to Bed:**

1. Release the catch on the table leg brace and fold the leg up against the bottom of the table.

2. Remove the table from the wall support bracket by lifting the end of the table. Then lower the table to rest on the cleats attached to each dinette bench.
3. Arrange dinette cushions to cover bed area.

#### **To Revert to Dinette:**

1. Replace table onto the wall support and lower the table leg.
2. Make sure that the table leg is secured into the floor support bracket and the leg brace is locked.

### **FOLD-UP LAVATORY (Model 420RG only)**

The fold-up lavatory is designed to store against the wall as a space saving measure when not in use.

#### **To Use:**

Release the latch which secures the lavatory against the cabinet and lower the lavatory into position.

#### **To Drain and Store:**

Raise the front edge of the lavatory toward the wall and fasten the latch. The water contained in the basin will flow into a concealed drain cavity behind the lavatory cabinet.

### **SHOWER MOUNTED CLOTHES ROD**

Your motor home may be equipped with a removable clothes rod mounted in the shower stall. This convenience allows for drying of wet or damp bathing towels, swim wear or other articles, and may be used as temporary storage for a limited number of light clothing articles. We recommend removing all articles from the clothes rod while the vehicle is in motion.

## CAUTION

Total weight of all articles suspended from the clothes rod must not exceed 35 lbs. Permanent damage to the clothes rod or the shower stall may result if the clothes rod is overloaded.

### POWER ROOF VENT - Bath Area

Some models are optionally equipped with a powered roof vent in the bath area. The switches which control the vent lift and the fan are typically located on the aisle side of the lavatory cabinet.

### POWER ROOF VENT - Galley Area

Some models may be optionally equipped with a powered roof vent in the galley area of the motor home.

A switch on the vent controls fan On-Off and fan speed. While this switch is in any of the fan speed positions, the fan motor will start automatically as the dome is raised. As the dome is closed, the fan motor will stop.

### REFRIGERATOR COMPARTMENT (Exterior)

The exterior refrigerator compartment allows access to the rear of the refrigerator for inspection, maintenance or service. The LP Gas Leak Detector is also located in this compartment. (See LP LEAK DETECTOR, Section 2.)

#### To Open:

1. Turn the latch knobs to the left 1/4 turn to the vertical position as shown.

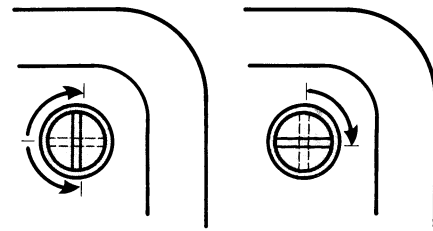

OPEN

CLOSE

2. Remove the door from the opening.

#### To Close:

1. Replace the door into the opening.
2. Push the latch knobs in while turning to the right 1/4 turn to the horizontal position as shown.

### CRANK-OUT SIDE WINDOWS

Turn the crank-out knob counterclockwise to open the window; clockwise to close. Do not use excessive force on the knob to lock the window in open or closed positions. This could cause permanent damage to the window crank mechanism.

**NOTE:** To gain easier access to the window crank-out knobs, you may temporarily unfasten the snaps at the bottom outside corner of the drapes.

## APPLIANCES

Refer to individual information supplied by the appliance and equipment manufacturers which is provided in your Owner's Information Packet.

### Water Heater

Refer to information provided in your Owner's Information Packet for operating safety and maintenance instructions.

## WARNING

Hydrogen gas can be produced in the water heater system served by a water heater that has not been used for an extended period of time, (usually two weeks or more). Hydrogen gas is extremely flammable. Due to risk of injury under these conditions, it is recommended that the hot water faucet be opened at the sink and the system totally filled before turning on the water heater. If hydrogen gas is present in the water system, there will probably be an unusual sound such as air escaping through the pipe as the water begins to flow. NEVER smoke or allow open flames near the faucet at the moment it is first turned on after an extended idle period or refilling of an empty system.

### Cooking Appliances

Refer to information provided in your Owner Information Packet for operating safety and maintenance instructions.

The following label has been located in the cooking area to fresh air for combustion. Unlike homes, the amount of oxygen supply you to provide an adequate supply of is limited due to the size of the recreational vehicle, and proper ventilation when using the cooking appliance(s) will avoid dangers of asphyxiation. It is especially important that cooking appliances not be used for comfort heating as the danger of asphyxiation is greater when the appliance is used for long periods of time.

## WARNING

IT IS NOT SAFE TO USE COOKING APPLIANCES FOR COMFORT HEATING

COOKING APPLIANCES NEED FRESH AIR FOR SAFE OPERATION. BEFORE OPERATION:

1. OPEN OVERHEAD VENT OR TURN ON EXHAUST FAN AND,
2. OPEN WINDOW.

## WARNING

Portable fuel-burning equipment, including wood and charcoal grills and stoves, shall not be used inside the recreational vehicle. The use of this equipment inside the recreational vehicle may cause fires or asphyxiation.

## SECTION 7: TRAVELING WITH YOUR MOTOR HOME

(See also Safety Precautions, Section 1 of this manual.)

### PRE-TRAVEL CHECK LIST

Before starting the engine on departure for an outing, be sure your motor home has been properly prepared and maintained. This will ensure an enjoyable trip and help avoid delays. Use this checklist as a guide.

**Tires** - Check for proper cold inflation pressures as specified on the Vehicle Certification Label.

**Wheel Lug Nuts** - Check for tightness.

**Lights** - Make sure all exterior lights operate properly.

**Fluid Levels** - Check and fill if necessary: engine oil, transmission, power steering, coolant, brake, battery, windshield washer, and auxiliary generator oil.

### WARNING

Never check oil level in auxiliary generator while engine is operating.

### LOADING THE MOTOR HOME

When loading your motor home, distribute the cargo load equally so that you do not exceed either the Front or Rear Gross Axle Weight Rating (GAWR) or the Gross Vehicle Weight Rating (GVWR). It may be necessary to have your motor home weighed to help determine the proper loading distribution for your vehicle. The diagram below illustrates gross weight ratings.



**Rear GAWR**  
(Rear Axle Only)



**Front GAWR**  
(Front Axle Only)

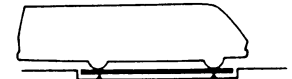

**GVWR**  
(Both Axles)

### WEIGHING YOUR MOTORHOME

We recommend that front suspension and steering alignment be checked and adjusted, if necessary, after the owner has fully loaded the motor home according to his needs. Thereafter, the alignment should be periodically inspected to prevent uneven tire wear.

## WARNING

Do not exceed the allowable weights.

### ROOF LOADING

The roof on most models is capable of carrying some lightweight articles while the vehicle is in motion. A roof-mounted luggage carrier designed for this purpose is available from your dealer. However, maximum roof load while the vehicle is in motion is not to exceed 10 pounds per square foot or a maximum of 100 pounds.

NOTE: Design and weight distribution considerations limit the use of the roof for storage on some models. Luggage carriers or other articles should not be placed or mounted on roofs of these vehicles. Consult your dealer for information regarding your model before loading the roof.

When the vehicle is stationary, a cargo load of 100 lbs. plus the weight of a 225 lb. person to load the cargo or to conduct inspection and maintenance is permissible.

Weight added to both the roof and the trailer hitch contribute to the gross vehicle weight, which must not exceed the vehicle's GVWR.

### TOWING

Vehicles which are equipped with factory installed trailer hitches have a towing capacity label affixed to the rear of the vehicle.

### TOWING CAPACITY

TOWED VEHICLE 1000 LB. GROSS MAXIMUM  
HITCH BALL 100 LB. MAXIMUM

Because of individual vehicle use and loading habits, we recommend weighing the vehicle while fully loaded to avoid exceeding any of the listed Gross Weight Ratings. Refer to the illustration "Weighing Your Motor Home" on page 7-1. See "Vehicle Certification Label" for information on gross weight ratings.

Towing will affect handling, durability and economy. Exceeding any of the listed Gross Weight Ratings will result in unacceptable overall vehicle performance. Maximum safety and satisfaction when towing depends on proper use of correct equipment.

Installation of a proper trailer brake system is recommended. Check state regulations concerning trailer weight and trailer brake requirements to ensure selection of suitable equipment before attempting to tow.



Before descending a steep or long grade when towing a trailer, reduce speed and shift into a lower gear to control vehicle speed. Avoid prolonged or frequent application of the brakes which could cause overheating.

## **WARNING**

For safe towing and vehicle handling, maintain proper trailer weight distribution.

The total weight of the motor home and the vehicle towed must not exceed the Gross Combined Vehicle Weight rating. Contact the chassis manufacturer to obtain the Gross Combined Vehicle Weight rating for your chassis.

## **CAUTION**

Exceeding any of the recommended gross weight ratings may result in vehicle damage.

Do not install a frame equalizing type hitch on your vehicle.

**VEHICLE CERTIFICATION LABEL**

All vehicles will display a vehicle certification label. On A-Body motor homes, this is located on the sidewall to the left of the steering wheel, or on the driver's door. On C-Body motor homes, the label is located on the lower area of the driver's door latch post. This label contains important information needed for future reference, such as vehicle identification, maximum weight limits, tire specifications, etc. (See following page for explanation of information.) Never destroy or remove this label.

MANUFACTURED BY <b>WINNEBAGO</b> <sup>®</sup> Winnebago Industries, Inc.		INCOMPLETE VEHICLE MANUFACTURED BY <b>1</b> MOTORS CORP	
<b>3</b>	MONTH AND YEAR OF MANUFACTURE: <b>2</b>		
	GVWR <b>4</b> LB. _____ KG		
GAWR:		SUITABLE TIRE AND RIM CHOICE	COLD INFLATION PRESSURE
F	LB _____ KG _____	TIRE _____	PSI _____ K Pa _____
R	<b>5</b> LB _____ KG _____	<b>6</b> _____	<b>8</b> PSI _____ K Pa _____
		RIM <b>7</b> _____	<b>9</b>
THIS VEHICLE CONFORMS TO ALL APPLICABLE FEDERAL MOTOR VEHICLE SAFETY STANDARDS IN EFFECT ON THE DATE OF MANUFACTURE SHOWN ABOVE.			
SERIAL NO. <b>10</b> _____		VIN <b>11</b> _____	
TYPE <b>12</b> _____		MODEL <b>13</b> _____ COLOR <b>14</b> _____	

## Explanation of Data

1. Chassis manufacturer.
2. Chassis manufacture date.
3. Month and year of manufacture at Winnebago Industries.
4. Gross Vehicle Weight Rating: Total permissible weight of the vehicle, including driver, passengers, total cargo carrier (including all liquids) and equipped with all options.
5. Gross Axle Weight Rating - Front/Rear: Total permissible weight allowed for the front axle (upper line) and the rear axle (lower line). (Listed in pounds and kilograms).
6. Suitable Tire Choice - Front/Rear: Tire recommended to meet handling and safety requirements. When replacing any of the tires on your vehicle, always replace with a tire that meets these specifications.
7. Suitable Rim Choice - Front/Rear: Wheel rim recommended to meet handling and safety requirements. When replacing any rim, always replace with a rim that meets these specifications.
8. Cold Inflation Pressure - Front/Rear: Inflation pressure recommended (while cold) for the tires originally equipped on your vehicle. These pressure levels must be maintained to assure proper handling, safety and fuel economy.
9. Rear Axle Wheel Configuration: Single, Dual, etc.
10. Serial Number: This is the serial number assigned to your vehicle by Winnebago Industries.
11. Vehicle Identification Number (VIN): This number is assigned by the chassis manufacturer. It is the legal identification number of your vehicle which will appear on the Certificate of Title and the Owner Registration Certificate.
12. Type: This blank states the usage classification to which your vehicle belongs.
13. Model: Lists the Winnebago product model number of your vehicle.
14. Color: Signifies the color code number of the decor used throughout the vehicle. This number is necessary for ordering replacement cushions, curtains, carpet, etc.



## SECTION 8: INSTRUMENTS AND CONTROLS

(See also SAFETY PRECAUTIONS, Section 1 of this manual.)

### **IMPORTANT**

This section describes only those instruments and controls which are unique to Winnebago and Itasca motor homes. For complete information regarding all other equipment, controls and instructions, consult the chassis manual or the equipment manufacturer's information provided in your Owner Information Packet. In addition, some items described may be optional or unavailable on certain models and, therefore, may not apply to your vehicle.

### **AUTOMATIC PARKING BRAKE - Models Equipped with John Deere Chassis Only**

Vehicles built on John Deere chassis are equipped with an automatic parking brake feature. When the transmission selector lever is placed into Park (P) position, the parking brake is automatically engaged.

A warning light on the instrument panel will remind you when the brake is engaged. The brake must be manually released after the transmission selector has been moved out of the Park position.

Consult your John Deere vehicle chassis manual regarding the correct procedure for releasing the parking brake.

### **IMPORTANT**

The parking brake will engage when the transmission is shifted into Park even while the engine is stopped. It cannot be released, however, unless the engine is running.

### **FUEL PUMP SHUT-OFF SWITCH - John Deere and Ford Chassis Only**

Vehicles built on John Deere and Ford chassis are equipped with an inertial type switch that shuts off the fuel pump in the event of collision. This switch must be manually reset to resume the fuel supply to the engine.

See your vehicle chassis manual for location and reset procedures for this switch.

### **IMPORTANT**

It is possible to inadvertently trigger this switch by abruptly striking an object such as a curb or parking block, for example. If your vehicle exhibits symptoms of running out of fuel immediately after such an occurrence, the fuel pump shut-off switch may need to be reset.

Consult your vehicle chassis manual for additional information.

**MULTI-FUNCTION SIGNAL LEVER - (Not available on model 319RB or models with Ford or John Deere chassis)**

The multi-function signal lever controls the turn signals, high/low beam changing, windshield washer, wipers and wiper delay, and the electronic speed control. (See illustrations.)

Detailed operating instructions are provided in your Owner Information Packet.

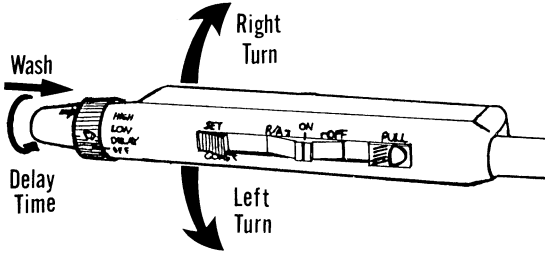
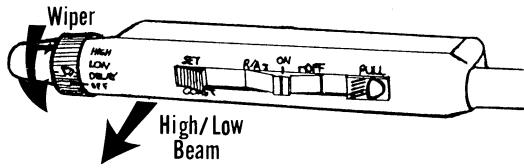

**ELECTRONIC SPEED CONTROL (CRUISE) - Models with Ford and John Deere Chassis Only**

Consult your vehicle chassis manual for operating instructions.

**ELECTRONIC SPEED CONTROL (CRUISE) - Model 319RB**

Refer to information supplied in your Owner Information Packet.

**Automotive Air Conditioner (C-Body, Chevrolet -Gas Engine Only) - Optional**

The air conditioner is controlled by two separate knobs located above the heater control panel. The "Air" knob controls fan speed while the "Temp" knob controls cooling temperature. The "Air" knob provides three fan speeds which are obtained by rotating the knob clockwise. Rotating the "Temp" knob clockwise produces colder air temperature. For maximum cooling, turn the "Air" knob to the high position and the "Temp" knob to the coldest position.

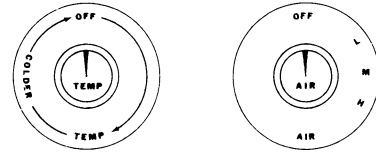

**IMPORTANT**

The automotive air conditioner is not designed to cool the entire interior of the motor home, but is intended to cool the driver's compartment only.

**Auto Air Conditioner/Heater (All A-Body) - Optional**

Controls for the air conditioner, heater, defroster and vent are all incorporated into one control panel. Refer to the following instructions for use of individual controls.

**Auto Air Conditioner** - To cool the driver's compartment, push the button labeled "A/C" or "MAX A/C". The "A/C" function blends fresh air with cooled air; the "MAX A/C" function continually recirculates inside air. Slide the top temperature lever to the left to obtain desired temperature. Turn the "Fan" selector switch to desired level of air output. Maximum cooling is achieved by pushing the "MAX A/C" button, sliding the temperature lever totally to the left (cool) and turning the fan switch to the "Hi" position.

**IMPORTANT**

The automotive air conditioner is not designed to cool the entire interior of the motor home, but is meant to cool only the driver's compartment.

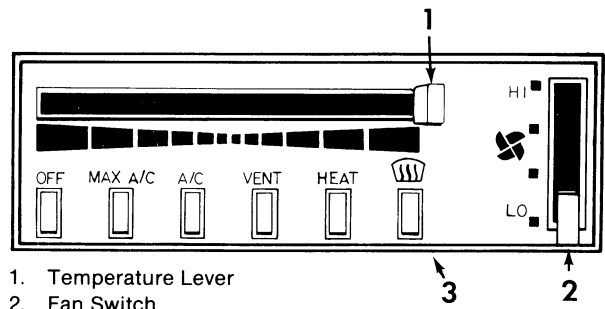

- 1. Temperature Lever
- 2. Fan Switch
- 3. Function Switches

**Heater** - To heat the driver's compartment, push in the "HEAT" switch. Turn the fan switch to desired level of air output and slide the temperature lever toward the right ("WARM") to obtain desired temperature.

**Defroster** - To defrost or defog the windshield, push in the "Defrost" switch. Turn the fan switch to desired level of air output and slide the temperature lever to the desired temperature.

**Vent** - To provide outside air to the interior of the motor home, push in the "Vent" switch. Turn the fan switch to desired level of air output and slide the temperature lever to desired temperature blend.

**Rear Auto Heater**

To provide auxiliary heat to the rear area of the vehicle, turn the rear heater fan switch to the desired speed.

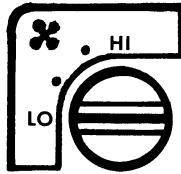
**BATTERY CONDITION METER AND SWITCH**

See related item under "Battery Information" in Section 3.

**DUAL BATTERY SWITCH**

See related item under "Battery Information" in Section 3.

**AUXILIARY BATTERY DISCONNECT SWITCH -Optional**

See related item under "Battery Information" in Section 3.

**AUXILIARY GENERATOR SWITCH**

See related information under "Auxiliary 110-Volt Generator" in Section 3.

**AUXILIARY GENERATOR HOURMETER**

See related information under "Auxiliary 110-Volt Generator" in Section 3.

**Map Light (Elandan/Windcruiser)**

The map light is mounted above the windshield on a "goose-neck" stalk. A master ON-OFF switch is located on the instrument panel. (See "INSTRUMENT PANEL - Elandan/Windcruiser") A secondary switch is located on the light, and is operated by slightly rotating the rounded rear section of the light. (This switch operates only while the master switch is on.)

Light intensity may be adjusted by slightly rotating the face bezel of the light, which opens or closes a set of apertures. If full intensity lighting is desired, the face bezel may be hinged open and snapped to the side of the light.

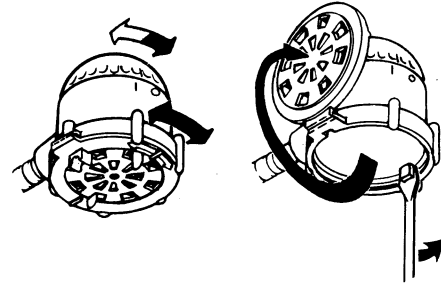

To replace a burned out bulb, carefully pry the lens out of the light using a coin or small screwdriver against the small tab on the lens. Always replace a bulb with one of the same type and size.



### **Beverage Tray Light (Elandan/Windcruiser)**

The beverage tray on the engine cover contains a small light for nighttime convenience. The switch for this light is located on the instrument panel to the right of the radio/cassette player.

### **Courtesy Lights (Elandan/Windcruiser)**

The courtesy lights are located near the floor of the driver's compartment ahead of the cab doors and illuminate while the cab doors are open. The switch, located on the instrument panel, allows you to turn the courtesy lights on while the doors are closed.

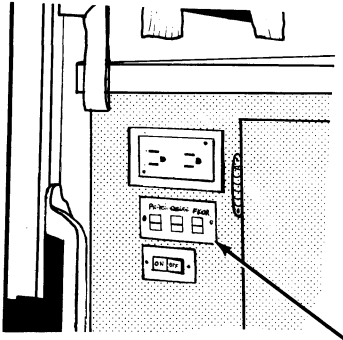

### **Aisle Light Switch (Elandan/Windcruiser)**

The aisle lights are mounted near the floor in various locations through the motor home to illuminate walkways. The master switch is located on the instrument panel. A control switch is located on a cabinet side near the entrance. The control switch functions only while the master switch is on.

### **Exterior Compartment Light Switch (Elandan/Windcruiser)**

This is the master switch for the exterior storage compartment lights. The lights may be individually activated in each compartment while this switch is on. Remember to shut switch off when not in use to prevent accidental battery discharge if a compartment switch is inadvertently left on.

### **Auxiliary Fan Switch**

If your vehicle is equipped with auxiliary defrost fans, a switch is located on the instrument panel.

### **ICC Courtesy Blink Switch**

May be used to momentarily blink clearance lights off and on when meeting another Winnebago/Itasca owner, for example, or anyone else you wish to greet in this manner. This function is also helpful in signaling to truckers when they may safely pull back into the lane after passing you. To use, press the right side of the switch momentarily and release. This switch will operate only while the headlight switch is in either the "Park" or "Headlight" position.

### **Air Horns - Optional**

A switch located on the lower left instrument panel activates the optional air horn system. While this switch is on, the air horns are sounded using the steering wheel horn button. When the switch is turned off, only the standard horns will sound.

NOTE: Since air horns are extremely loud, it is recommended that you deactivate them while driving in areas where noise abatement ordinances may be in effect.

A 50 foot air hose is also supplied with the vehicle if equipped with air horns. The hose may be connected to the air horn compressor in the engine compartment and used to inflate beach equipment, air mattresses, tires, etc.

### REMOTE-CONTROLLED SIDE MIRRORS - A-Bodies Only

The side mirrors are adjusted using a multi-directional switch located on the driver's door or the driver's side panel.

Elandan and Windcruiser models are equipped with a single control which contains a mirror selector switch, while all other models use individual controls for each mirror. (See illustrations).

The mirrors also contain heating elements to defog or de-ice the mirror glass during cold weather operation. An ON-OFF switch for the mirror heaters is located near the remote mirror controls.

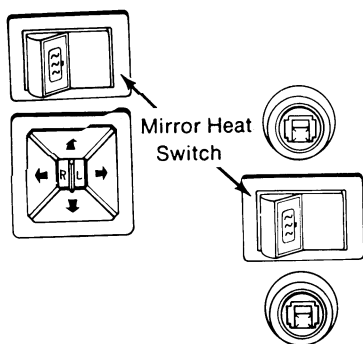

### REAR WINDOW WIPER

**Chieftain/Sunflyer models 27RT, 27RU, 31RT & 33RU; Superchief/Suncruiser models 27RQ, 31RQ & 34RQ**

The optional rear window wiper is controlled by a switch on the instrument panel. Refer to the instrument panel illustration for your model for the specific location of this switch.

### COACH LEVELING SYSTEMS

Coach leveling systems are designed to diminish site selection problems, making "set up" at a camping site faster and more convenient for you.

#### IMPORTANT

When parking at an uneven site, always park the front of the motor home to the downhill side. This allows you to level by raising the front end rather than the rear. Since only the rear wheels are locked while in PARK, raising the rear wheels off the ground could allow the vehicle to roll off the jacks.

### HWH Hydraulic Leveling System

The leveling system control panel is located on the floor to the left of the drivers seat. Each of the four leveling units (jacks) is controlled by its own lever.

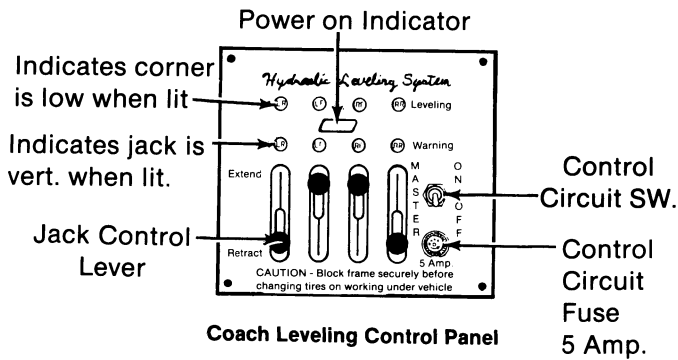

**With Park & Level™** - The red Auto/Manual switch should be placed in the Automatic (up) position before driving off. The switch handle emits a red light to alert the operator when the system is in the Park & Level™ (Manual) mode.

The optional **Park & Level™** system incorporates electronic air distribution controls for vehicle leveling purposes. It allows air spring pressure to be manually adjusted up-and-down or side-to-side to simulate the function of a hydraulic leveling system. This provides the vehicle owner with a reasonable degree of flexibility in parking/camping site selection.

**To Level the Motor Home:**

1. Be sure the vehicle is in PARK and the parking brake is applied.
2. Turn the Master switch ON.
3. Operate the jack levers alternately, beginning with the front leveling units, until all of the lights on the lever control panel are off, indicating that the vehicle is level.
4. Turn the Master switch off.

**Airlift Sensoride™ Suspension System (Including Park & Level™ Feature)**

**OPERATING INSTRUCTIONS**

**Normal Driving (Automatic Leveling)**

**Without Park & Level™** - No special instructions or precautions must be observed since the system is always in road travel mode.

**CAUTION**

Do not drive the vehicle with the Auto/Manual switch in the Manual position (red handle lit). Damage to suspension components could result.

**NOTE:** Automatic leveling is deactivated when the ignition is switched off. Therefore, it is possible for the vehicle to appear "jacked up" in the rear under certain circumstances.

An example situation would be if several people were occupying the rear of the coach while the ignition is switched off. The height control valves would be compensating for the extra load at the time of power down by adding air pressure to the springs. When the ignition is turned off, the additional air remains inside the springs. When the occupants exit the coach, thereby subtracting the excess weight from the rear, the rear of the vehicles rises.

This is not a malfunction and should be no cause for alarm. When the vehicle is restarted, the automatic leveling system will immediately correct this situation.

### Park & Level™ Controls

The optional Park & Level™ control panel is located at the lower left-hand side of the dash. It contains 3 toggle switches and a compressor indicator light.

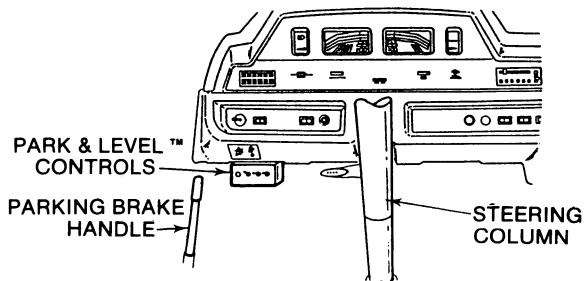

### Leveling

Flip the red toggle switch to "Manual". The switch will illuminate to indicate that the leveling feature is activated. Level the vehicle by operating the black switches.

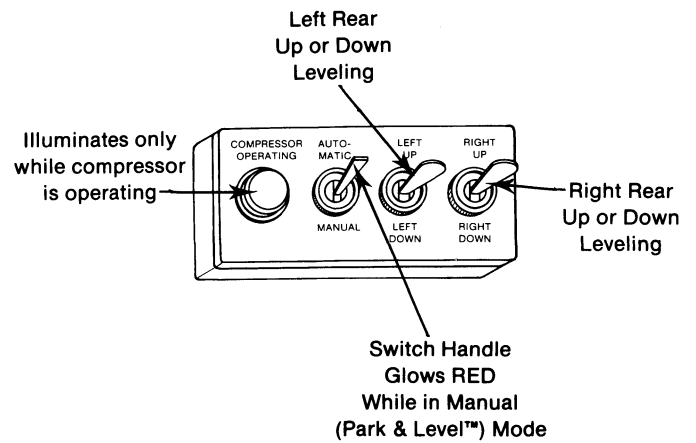

- When raising the rear of the vehicle, operate **both** springs at the same time to provide maximum lifting power.
- When parked on a side hill, raise both springs as mentioned above, then lower the spring on the "uphill" side until the vehicle is level.
- When you're ready to drive off, switch the mode to "Automatic". The springs will automatically be adjusted for road travel.

### Compressor Light

The red indicator light labeled "Compressor Operating" will illuminate only while the compressor is operating. When air pressure depletes to a preset minimum amount, the compressor will operate until maximum pressure is restored.

The compressor normally operates periodically while driving to maintain air pressure in the system. It will also operate for a few minutes after starting the vehicle and switching the Auto/Manual switch back to "Automatic" (when Park & Level™ has been in use) to restore air pressure released during leveling.

### PERIODIC MAINTENANCE

There are very few items on this suspension system that require periodic maintenance. Here are a few simple maintenance suggestions:

- Purge moisture from air reserve and accumulator tanks before freezing temperatures and/or vehicle storage. Turn the butterfly valve on the bottom of each tank 90° to expel water. Close the valve when water stops spraying from the valve.

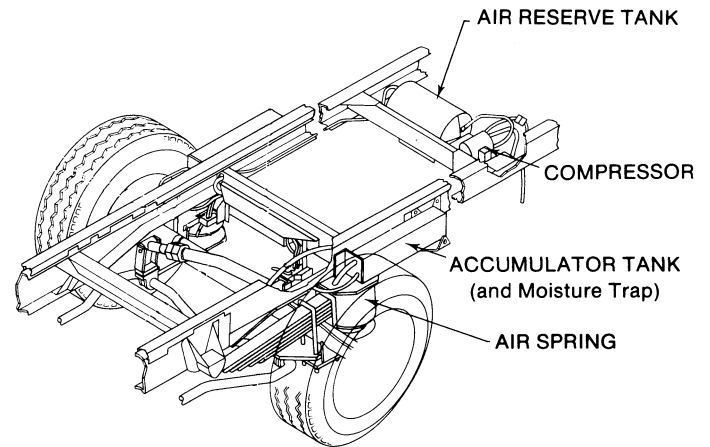

- Periodically inspect air springs for cracks that could develop into rips or holes.
- Periodically inspect air hoses for abrasions, pinholes or other conditions which could result in air leaks.
- Pressure wash underside of vehicle periodically to avoid build-up of mud on suspension components, which can prematurely wear moving parts.

## AUDIO ENTERTAINMENT SYSTEMS

Most vehicle models are available with optional or standard audio entertainment systems that provide high quality stereo sound for your travelling and living enjoyment. Refer to your Owner Information Packet for operating and care instructions.

### CAUTION

If your radio is equipped with an electronic tuning receiver, disconnect the radio power leads before attaching a battery charger or jumper cables to the battery. The radio tuner may become damaged if this is not done.

### Rear View Monitor System - Optional (Elandan/Windcruiser & Superchief/Suncruiser models only)

The rear monitor is a closed-circuit television camera and monitor which perform the task of a rear view mirror. Because the monitor screen provides incremental distance markings, parking and other backing maneuvers can be performed with greater confidence and accuracy.

Power is provided to the system by the vehicle's ignition switch. When the ignition is on, the system is on. The picture will appear while the transmission is shifted into reverse. The Reception/Brightness switch allows you to turn the picture on while driving forward, if desired.

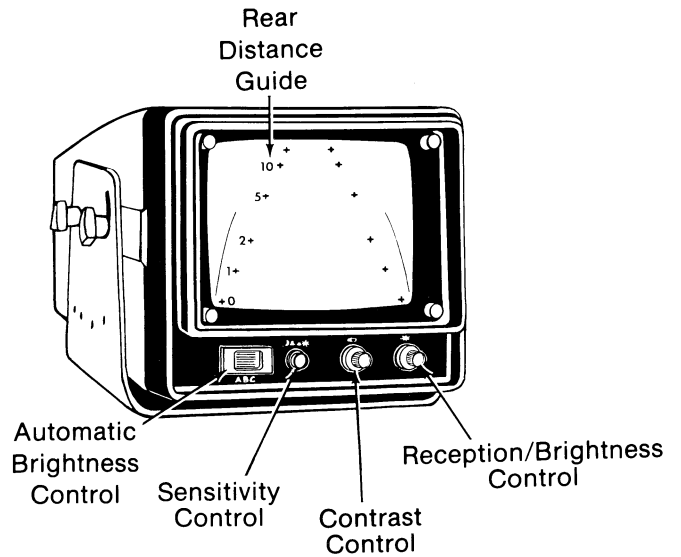

Refer to the manufacturers information provided in your Owner Information Packet for further instructions.

## VACUUM - FUEL ECONOMY GAUGE (Gas Engine A-Body Only) - Optional

This gauge provides a guide to efficient engine operation. It is impossible to specify an ideal gauge reading, as this will vary a great deal according to operating conditions. However, as a general rule, a high reading usually indicates the most efficient engine operation and the best fuel economy. The vacuum level will be high at idle speed, and as speed and load increase, the vacuum level will drop. To obtain maximum fuel economy, operate the motor home in such a way as to maintain vacuum level as high as possible.

### CAUTION

Do not operate the optional 110V generator while driving if the battery switch is in the dual position. This can cause damage to the automotive alternator.

## DOOR LOCKS AND HANDLES

### EXTERIOR

#### Elandan and Windcruiser (Also Chieftain/Sunflyer with passenger door roll-up window)

To unlock the entrance and cab doors from the outside of the vehicle, insert the key into the lock and turn toward the front of the vehicle. To lock, turn the key toward the rear of the vehicle or simply push the lock switch on the inside of the door and close the door.

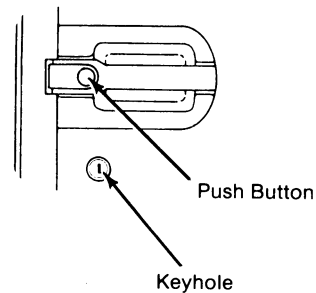

## INTERIOR

### Elandan and Windcruiser (Also Chieftain/Sunflyer with passenger door roll-up window)

To open the cab and entrance doors from the inside of the vehicle, pull the latch lever outward. The doors are locked from the inside of the vehicle using the lock rocker switch. Deadbolts are also provided for extra security.

#### IMPORTANT

Keys should always be removed when leaving the vehicle. Since doors can be locked without keys, make sure they have been removed from the ignition before locking the driver's compartment.

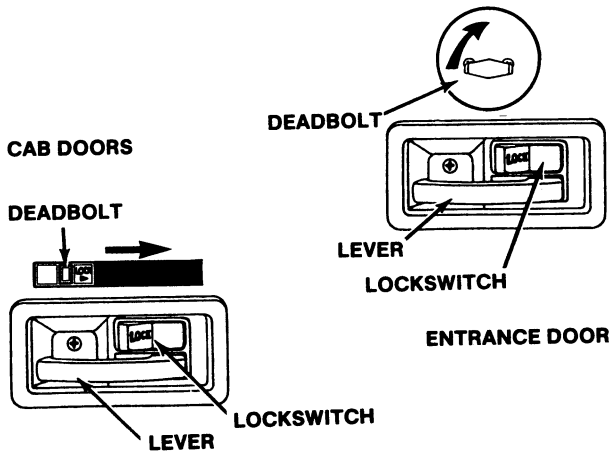

### COACH ENTRANCE DOOR\* (Except Elandan and Windcruiser)

The entrance door can be locked or unlocked from the outside of the vehicle by inserting the key into the lock and turning. To lock the door from inside, slide the lock button to the right. The deadbolt locks are for added security and should be used as security night locks. Lubricate the locks periodically with graphite to maintain good working condition.

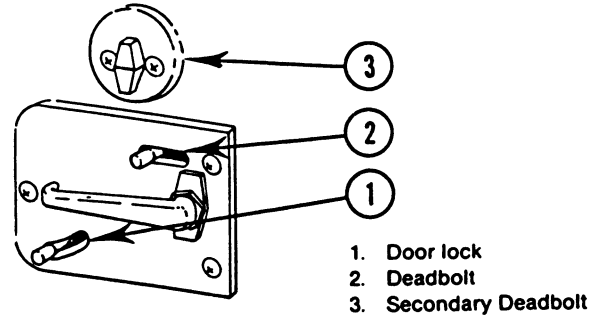

Interior Entrance Door Handle

\* Also used on optional cab doors of Chieftain, Sunflyer, Superchief and Suncruiser models.



## ENTRANCE DOOR HANDLE

The entrance door may be opened from outside the vehicle by pulling the door handle outward. To open the door from inside, pull upward on the door handle. When the door is locked, neither the inside nor the outside door handle can be operated.

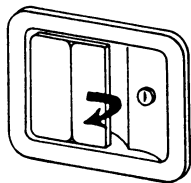

Exterior Entrance Door Handle

## CAUTION

When releasing security night lock, be sure to retract bolt before opening door latch to prevent drag on bolt pin. Instruct all passengers in operation of this door catch system as well as emergency exit window.

Never force the inside door handle downward, as damage could occur.

## DRIVER COMPARTMENT DOOR LOCK (C-Body Only)

Consult your vehicle chassis manual.

## ENTRANCE STEP - Manual

To extend the entrance step, lift up on the front of the step and pull out until it drops into position. To retract, lift up on front of step and push back until step locks into travel position.

## ENTRANCE STEP - Powered

The optional electric power entrance step extends and retracts automatically as the entrance door is opened and closed. If the door will be repeatedly opened and closed while parked at a site, you may want to cancel the power to the step for convenience and to conserve wear on the mechanism. A rocker switch for this purpose is located on the side of the cabinet directly to your left as you enter the motor home.

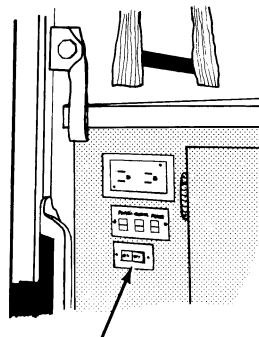

With this switch turned off, the step will remain in whichever position it was when power was cancelled. Turn the switch on to reactivate the power step mechanism.

## CAUTION

Always remember to retract the entrance step before traveling or moving the vehicle.

### SEATS - Standard (Except Elandan & Windcruiser)

The driver and co-pilot seats may be independently adjusted to suit individual preference. To move the seat forward or backward, move the slide release lever, located under the front of the seat, to the left and exert slight body pressure in the direction desired.

The seats may be swiveled to provide easy entrance and exit. The swivel feature also allows the seats on some models to be turned toward the living area for additional seating while the unit is parked. To swivel the seats, press the release lever, located on the right side of the seat, to the rear and rotate seat. The seats are designed to lock only when returned to the forward facing position.

To recline the seats, depress lever 3, lean back to desired incline and release the lever. To return to the upright position, depress the lever and lean body forward. Allow the seat to return to the desired position and release the lever.

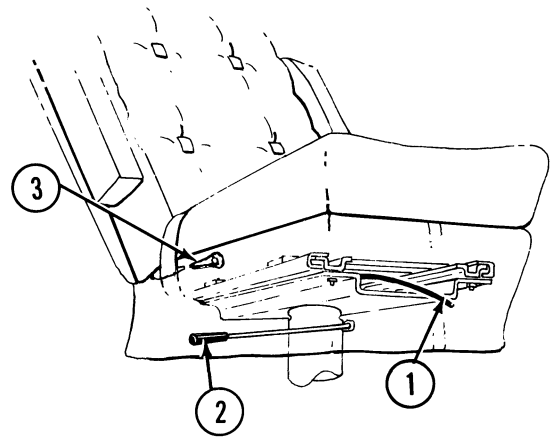

#### Driver and Passenger Seat

1. Slide Release Lever
2. Swivel Release Lever
3. Reclining Lever

## WARNING

Do not adjust drivers seat while vehicle is in motion.

After adjusting seat, always use body pressure to make sure slide and swivel locking mechanisms have engaged.

### Arm Rest Adjustment

The seat assembly arm rest may be adjusted to alter the angle at which the arm rest will remain when placed in the lowered position. To reposition the arm rest angle, proceed as follows:

Position 1 - Raise armrest, push in toward seat body and lower into position.

Position 2 - Raise armrest, pull outward from seat body and lower into position.

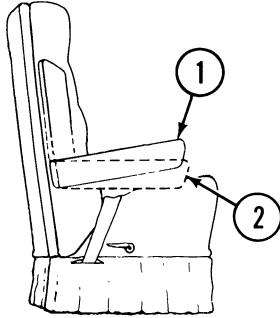

### SEATS - Elandan and Windcruiser

The recliner and slider controls are located at the front of the armrests.

**To Recline:** The control lever is located at the front of the right armrest.

1. Lean body forward slightly to reduce pressure on seat back.
2. Pull upward on control lever.
3. Lean body and seat back to desired angle of recline.
4. Release lever.

Return the seat back to an upright position by pulling the control lever upward and leaning your body forward at the same time.

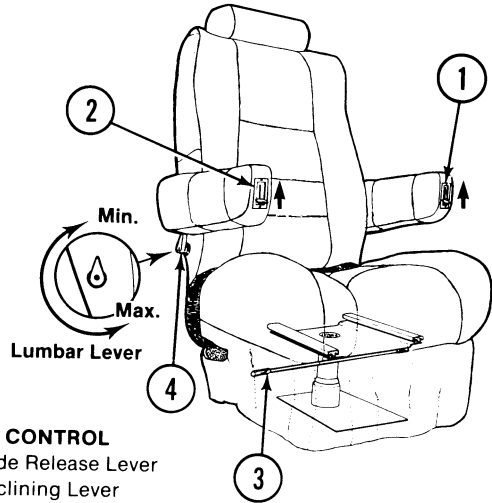

### SEAT CONTROL

1. Slide Release Lever
2. Reclining Lever
3. Swivel Release Lever
4. Lumbar Control Lever

**To Move The Seat Forward or Backward:** The control lever is located at the front of the left armrest.

1. Pull upward on control lever.
2. Use body motion to move seat forward/backward as desired.
3. Release lever.

**Armrest Adjustment:** See "Seats - Standard"

### SEATS - Optional 6-Way Powered

The driver and co-pilot seats are adjusted using the switch panel shown, located on the left-hand side of the seat. Switch 1 controls seat front elevation and switch 2 controls the seat rear elevation. The fore-aft positioning of the seat is controlled by switch 2.

Refer to "Seats - Elandan & Windcruiser" for armrest positions and seat reclining instructions.

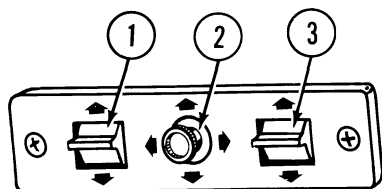

Power Seat Control

### Swivel/Recliner Lounge Chairs

Some vehicles are equipped with lounge chairs which swivel and recline. They may also be moved fore and aft on a slider mechanism. Refer to "Seats - Elandan and Windcruiser" for reclining and slider adjustment instructions.

These chairs feature a side-facing swivel lock for your safety while the vehicle is moving.

**To Lock:** The lock handle is located below the right side of the seat, behind the skirt.

1. Turn handle so that it points either upward or downward.
2. Swivel chair to aisle-facing position.
3. When you hear a "click", seat is locked into position.

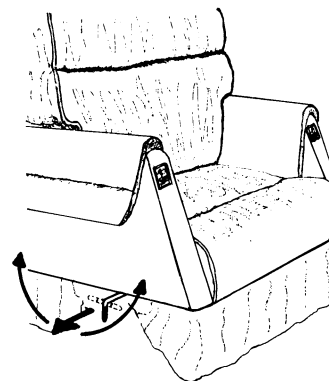

**To Unlock:** Pull the handle outward (away from the seat base) and turn it to a horizontal position. The seat can now swivel freely.

### SEAT BELTS

Seats intended for occupancy while the vehicle is in motion are equipped with seat belts for the protection of the driver and passengers. The lap belts must be worn as low as possible and fit snugly across the hip area. Always sit erect and well back into the seat. To implement full protection of the safety belt, never allow more than one occupant to use the same safety belt at any one time, and do not let the safety belts become damaged by pinching them in the doors or in the seat mechanism. After any serious accident, any safety belts which were in use at the time should be replaced.

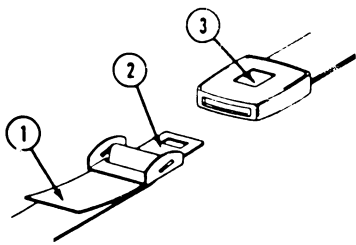

#### Seat Belt

1. Adjustment Strap
2. Tongue
3. Release Button

**Adjustment:** To lengthen belt, turn tongue at a right angle to belt and pull to desired length. To shorten, pull loose end of belt.

**To Fasten:** Be sure belt is not twisted. Grasp each part of the belt assembly and push tongue into buckle. Adjust to a snug fit by pulling the loose end away from the tongue.

**To Release:** Depress button in center of buckle and slide tongue out of buckle.

## WARNING

Snug and low belt positions are essential. This will ensure that the force exerted by the lap belt in a collision is spread over the strong hip area and not across the abdomen, which could result in serious injury.

Only seats equipped with seat belts are to be occupied while vehicle is in motion. Seats not equipped with seat belts will be labeled: "This seat not intended for occupancy while vehicle is in motion."

## Child Restraints

All 50 of the United States and the District of Columbia now require the use of child/infant restraint systems for children in vehicles.

A properly installed and secured child restraint system can help reduce the chance of severity of personal injury to a child in an accident or during a sudden maneuver. Children may be injured in an accident if they are not seated in a child restraint system or if seated in a child restraint system which is not properly secured.

A child restraint system is designed to be secured in a vehicle seat by a lap belt or the lap belt portion of a lap-shoulder belt. According to accident statistics, children are also safer when properly restrained in rear seating positions than in front seating positions.

**When purchasing a child restraint system:**

1. Look for the label certifying that it meets all applicable U.S. Federal Motor Vehicle Safety Standards (FMVSS) or, in Canada, requirements of the Children's Car Seats and Harnesses Regulations (CCSHR).
2. Make sure that it will attach to your vehicle and restrain your child securely and conveniently so that you are able to install it correctly each time it is used.
3. Be certain that it is appropriate for the child's height, weight and development. The instructions and/or the regulation label attached to the restraint typically provides this information.
4. Review the instructions for installation and use of the restraint. Be sure that you understand them fully and can install the restraint properly and safely in your vehicle.

## INSTRUMENT PANEL - Minnie Winnie/Sundancer (Toyota Chassis)

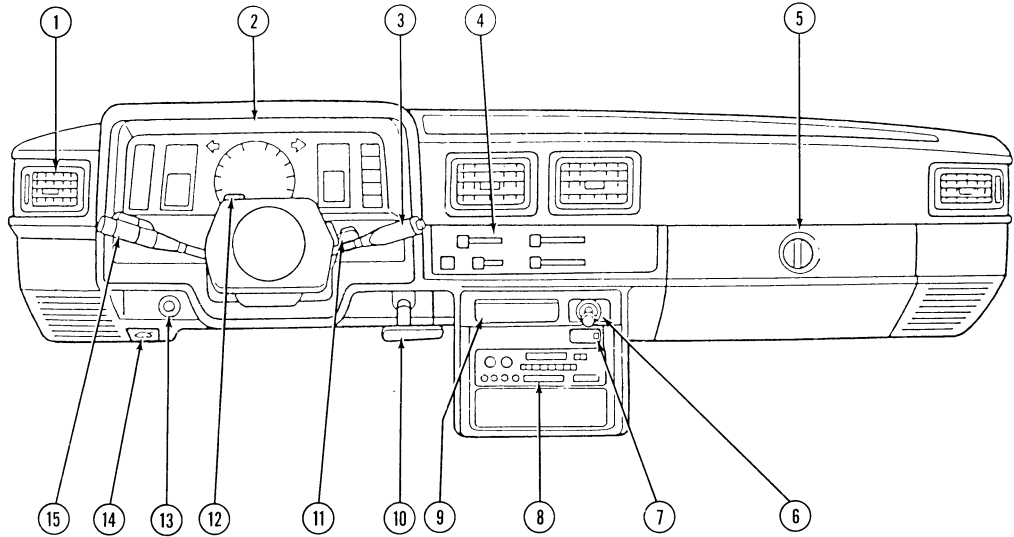

- |                                    |                                |                              |
|------------------------------------|--------------------------------|------------------------------|
| 1. Vent Register                   | 6. Cigarette Lighter           | 11. Ignition Switch          |
| 2. Instrument Cluster§             | 7. Overdrive Indicator Light   | 12. Emergency Flasher Switch |
| 3. Windshield Wiper/Washer Switch  | 8. Audio Entertainment System* | 13. Instrument Panel Dimmer  |
| 4. Heater/Air Conditioner Controls | 9. Ashtray                     | 14. Hood Release             |
| 5. Glove Compartment               | 10. Park Brake Lever           | 15. Headlight/Dimmer/Signal  |

\* Optional

§ See vehicle chassis manual for description and function.

## INSTRUMENT PANEL - Minnie Winnie/Sundancer (Ford Chassis)

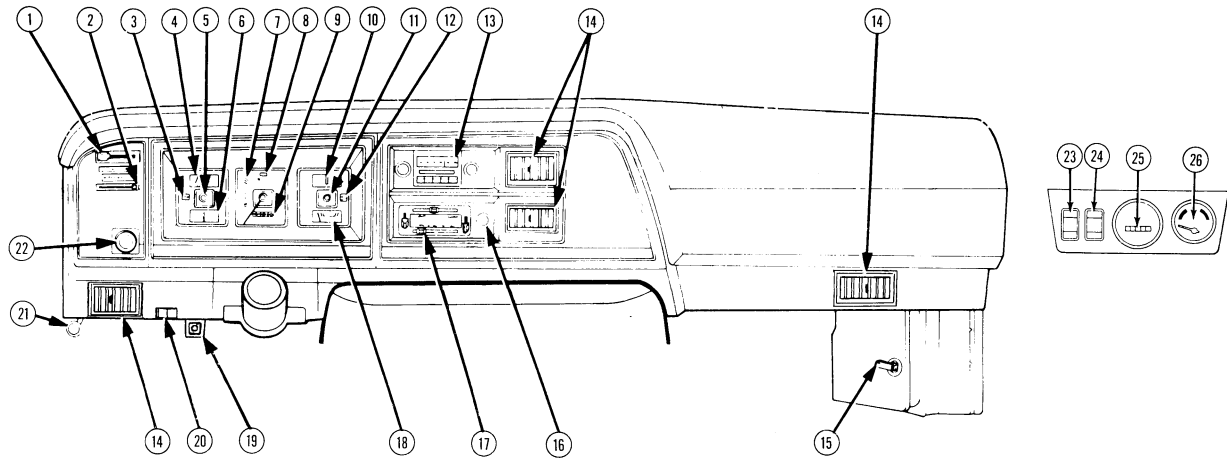

- |   |                                      |   |
|---|--------------------------------------|---|
| 1. Windshield Wiper/Washer Switch§      | 10. Alternator Indicator§            | 20. Battery Mode Switch                             |
| 2. Rear Windshield/Wiper/Washer Switch* | 11. Right Turn Indicator§            | 21. Left Fresh Air Vent Knob§                       |
| 3. Seat Belt Reminder Light§            | 12. Brake Warning Light§             | 22. Headlight Switch§                               |
| 4. Oil Pressure Indicator§              | 13. Radio                            | 23. Battery Condition Switch*                       |
| 5. Left Turn Indicator§                 | 14. Vent/Air Cond. Register§         | 24. Auxiliary Electric Generator Start/Stop Switch* |
| 6. Fuel Gauge§                          | 15. Right Fresh Air Vent Knob        | 25. Auxiliary Electric Generator Hourmeter*         |
| 7. Speedometer§                         | 16. Cigarette Lighter                | 26. Battery Condition Meter*                        |
| 8. High Beam Indicator§                 | 17. Heater/Air Conditioner* Controls |   |
| 9. Odometer§                            | 18. Engine Temperature Gauge§        |   |
|   | 19. Fog Light Switch*                |   |

\* Optional

§ Consult vehicle chassis manual for functions and descriptions.

**INSTRUMENT PANEL - Minnie Winnie/Sundancer (Chevrolet Chassis)**

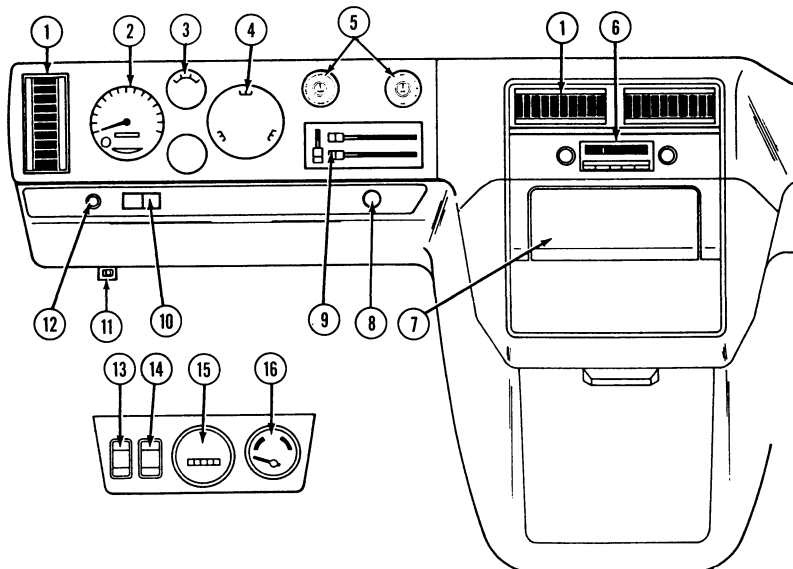

- |                                    |  |   |
|------------------------------------|--|---|
| 1. Vent/Air Cond. Register         | 8. Rear Auto Heater Switch (Model 424RC only)*       | 13. Battery Condition Switch*                       |
| 2. Speedometer/Warning Lights §    | 9. Heater/Air Cond. Controls - Diesel*               | 14. Auxiliary Electric Generator Start/Stop Switch* |
| 3. Fuel Gauge                      | 10. Glow Plugs/Water in Fuel Indicator (Diesel Only) | 15. Auxiliary Electric Generator Hourmeter*         |
| 4. Engine Monitor Gauges §         | 11. Fog Light Switch*                                | 16. Battery Condition Meter*                        |
| 5. Air Conditioner Controls - Gas* | 12. Headlight Switch                                 |   |
| 6. Audio Entertainment System*     |  |   |
| 7. Ashtray/Cigarette Lighter       |  |   |

\* Optional

§ See vehicle chassis manual for description and function.



**INSTRUMENT PANEL - Chieftain/Sunflyer/Superchief/Suncruiser  
(John Deere Chassis - Standard Instrument Cluster)**

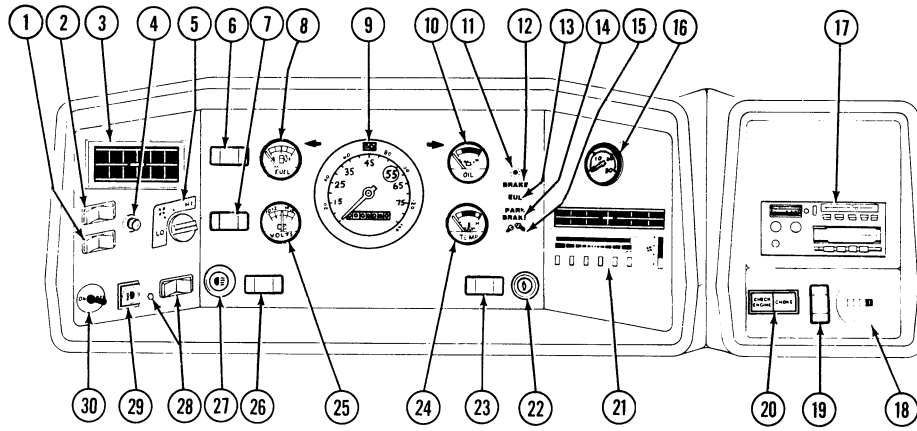

- |                                  |   |  |
|----------------------------------|---|--|
| 1. Windshield Washer Switch      | 11. Bright Light Indicator                          | 21. Heater/Air Conditioner* Control      |
| 2. Windshield Wiper Switch       | 12. Brake System Warning Indicator                  | 22. Cigarette Lighter                    |
| 3. Vent/Air Conditioner Register | 13. EUL Indicator                                   | 23. Rear Wiper Switch*                   |
| 4. Wiper Delay Control           | 14. Park Brake Warning Light                        | 24. Coolant Temp. Gauge                  |
| 5. Rear Auto Heater Switch*      | 15. Seat Belt Indicator                             | 25. Battery Condition Meter              |
| 6. Battery Condition Switch      | 16. Vacuum/Fuel Economy Gauge                       | 26. Rear Fan Switch                      |
| 7. Battery Mode Switch           | 17. Audio Entertainment System*                     | 27. Headlight Switch                     |
| 8. Fuel Gauge                    | 18. Auxiliary Electric Generator Hourmeter          | 28. Auxiliary Battery Disconnect Switch* |
| 9. Speedometer                   | 19. Auxiliary Electric Generator Start/Stop Switch* | 29. Fog Light Switch*                    |
| 10. Oil Pressure Gauge           | 20. Choke/Check Engine Indicator                    | 30. Air Horn Switch*                     |

\* Optional

§ See vehicle chassis manual for description and function.

**INSTRUMENT PANEL - Chieftain/Sunflyer/Superchief/Suncruiser  
(Chevrolet Chassis - Standard Instrument Cluster)**

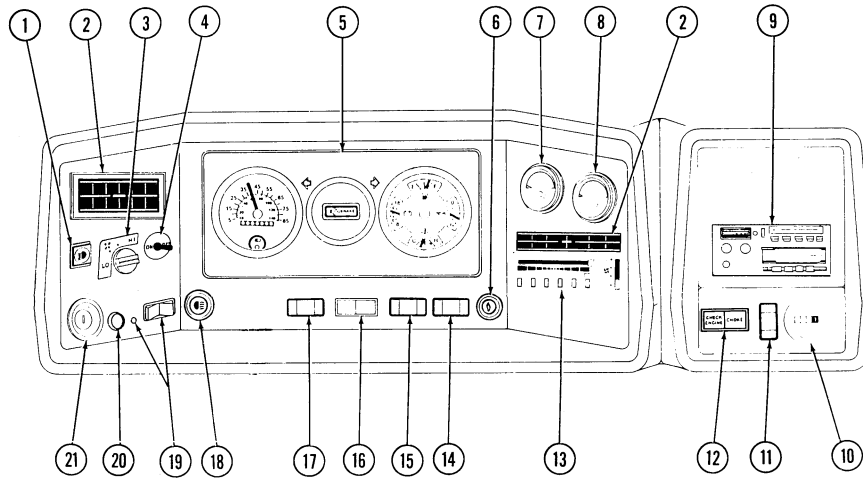

- |   |   |   |
|---|---|---|
| 1. Fog Light Switch*                      | 9. Audio Entertainment System*                      | 16. Glow Plugs/Water in Fuel Indicator (Diesel) |
| 2. Vent/Air Conditioner Register          | 10. Auxiliary Electric Generator Hourmeter*         | 17. Rear Wiper Switch*                          |
| 3. Rear Auto Heater Switch*               | 11. Auxiliary Electric Generator Start/Stop Switch* | 18. Headlight Switch                            |
| 4. Air Horn Switch*                       | 12. Choke/Check Engine Indicator                    | 19. Auxiliary Battery Disconnect Switch*        |
| 5. Instrument Cluster§                    | 13. Heater/Air Conditioner* Controls                | 20. Low Coolant Indicator (Diesel)              |
| 6. Cigarette Lighter                      | 14. Battery Mode Switch (N/A Diesel)                | 21. Ignition Switch                             |
| 7. Battery Condition Meter                | 15. Battery Condition Switch                        |   |
| 8. Vacuum/Fuel Economy Gauge (N/A Diesel) |   |   |

\* Optional

§ See vehicle chassis manual for description and function.

**INSTRUMENT PANEL - Chieftain/Sunflyer/Superchief/Suncruiser  
(Chevrolet Chassis - Electronic Instrument Cluster)**

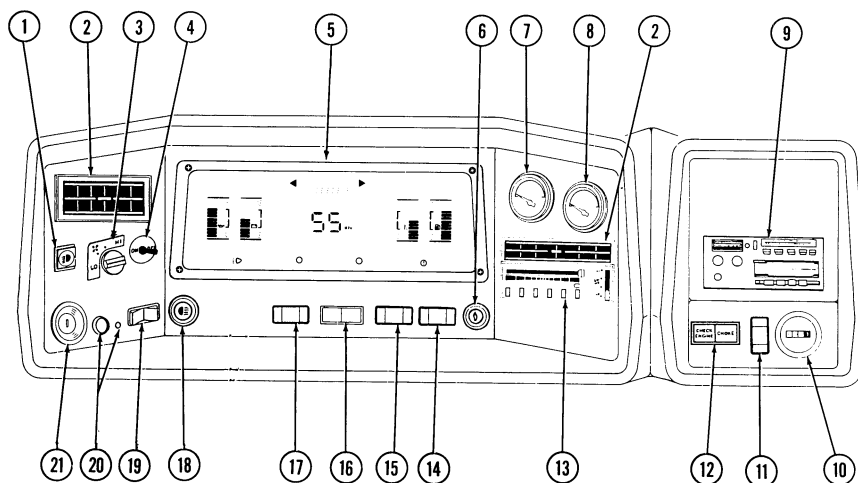

- |   |  |   |
|---|--|---|
| 1. Fog Light Switch*                      | 9. Audio Entertainment System*                 | 16. Glow Plugs/Water in Fuel Indicator (Diesel) |
| 2. Vent/Air Conditioner Register          | 10. Auxiliary Electric Generator Hourmeter*    | 17. Rear Wiper Switch*                          |
| 3. Rear Auto Heater Switch*               | 11. Aux. Electric Generator Start/Stop Switch* | 18. Headlight Switch                            |
| 4. Air Horn Switch*                       | 12. Choke/Check Engine Indicator               | 19. Auxiliary Battery Disconnect Switch*        |
| 5. Instrument Cluster*§                   | 13. Heater/Air Conditioner* Controls           | 20. Low Coolant Indicator (Diesel)              |
| 6. Cigarette Lighter                      | 14. Battery Mode Switch (N/A Diesel)           | 21. Ignition Switch                             |
| 7. Battery Condition Meter                | 15. Battery Condition Switch                   |   |
| 8. Vacuum/Fuel Economy Gauge (N/A Diesel) |  |   |

\* Optional

§ See "Electronic Instrument Panels" in this section for description and function of electronic gauges.

**INSTRUMENT PANEL - Chieftain/Sunflyer/Superchief/Suncruiser  
(Chevrolet Chassis - Electronic Instrument Cluster)**

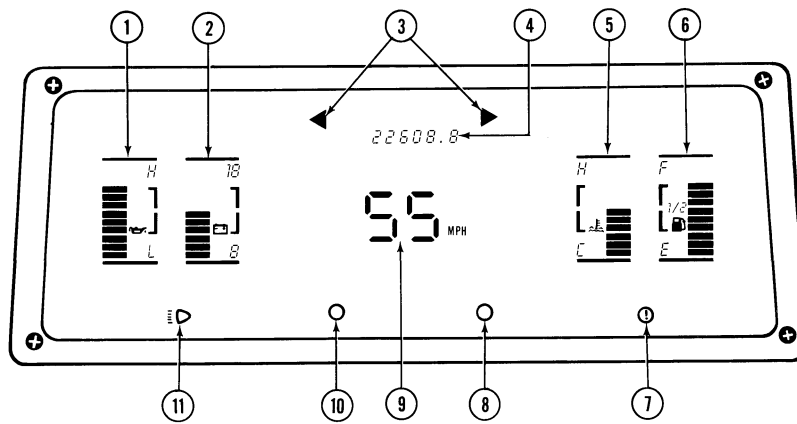

**DISPLAY FEATURES**

The digital cluster displays the same information that a standard cluster does, except that it uses fluorescent digital numbers and bar graph gauges to display information, rather than dials and needles.

The dash contains a memory that stores mileage and mode information, so the odometer mileage and MPH-km/h mode will always remain the same as when the vehicle was last driven.

1. **Oil Pressure Gauge** - Indicates approximate oil pressure while engine is operating. The gauge symbol will blink if oil pressure drops below warning level (approx. 3 bars).
2. **Battery Voltage Gauge** - Indicates battery voltage from approximately 8 to 18 volts. If voltage drops below 12 volts, the gauge symbol will flash as a warning.
3. **Turn Signal Indicators** - One of the green arrows will flash to correspond to the direction selected with the turn signal lever. Both arrows flash in unison when emergency warning flashers are activated.

- 4. **Odometer** - Displays total vehicle miles traveled in MPH or km/h as selected with the mode selector button (#8). Also displays trip odometer using the trip odometer selector button (#10). A small **t** will appear at the left end of the display to indicate miles traveled since last reset.

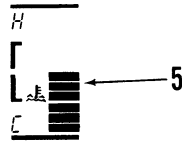

- 5. **Coolant Temperature Gauge** - Indicates approximate engine coolant temperature in degrees F. The gauge symbol will flash if the coolant temperature exceeds the warning level (approx. 240 degrees F.).

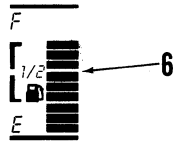

- 6. **Fuel Level Gauge** - The low fuel warning will begin to flash when the fuel indicator displays less than 1/4 tank (3 bars or less).

- 7. **Brake Warning Indicator** - The red brake warning symbol will flash when brakes are applied if there is a loss of hydraulic pressure in either half of the dual braking system.

**WARNING**

Any indicated malfunction in the hydraulic braking system should receive immediate attention to avoid possible loss of braking and personal injury.

The warning light also glows steadily while the parking brake is applied while the ignition key is in the ON or START position.



- 8. **MPH-km/h Mode Selector** - Push the lower right-hand button to select the display mode (MPH or km/h) for the speedometer, odometer and trip odometer.



9. **Speedometer** - Displays vehicle speed from 0-85 MPH or 0-137 km/h as selected with the mode selector button. (See #8.) Each time the motor home is started, the speedometer will display **188** for a short period to verify proper display operation.

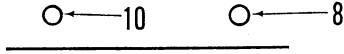

10. **Trip Odometer Selector/Reset** - To turn the trip odometer function on or off, press and release the lower left-hand button. While the trip odometer function is in use, a small **t** will appear at the left end of the odometer display. To reset the trip odometer, press and hold the button until the display resets to zero (approximately 2-3 seconds).

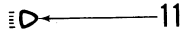

11. **High Beam Indicator** - The blue headlight symbol illuminates when high beams are selected.

## INSTRUMENT PANEL - Elandan/Windcruiser (Standard Instrumentation)

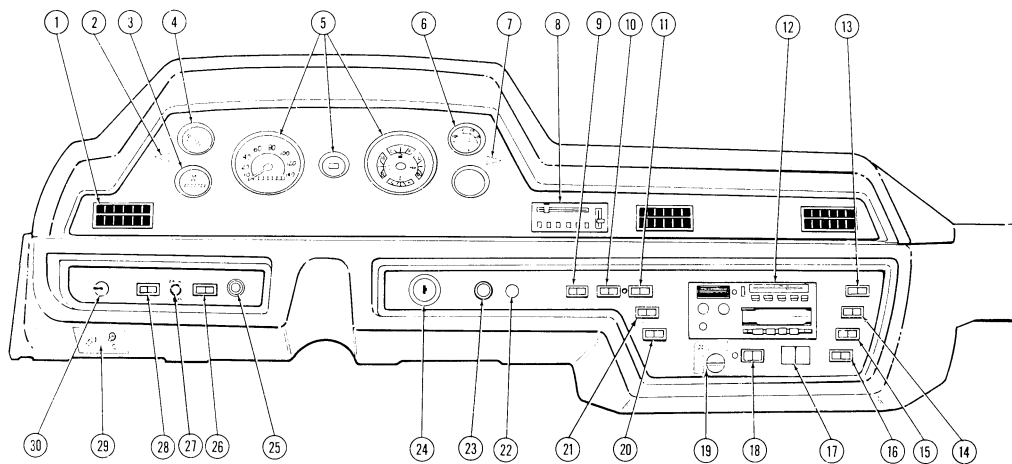

- |                                   |   |  |
|-----------------------------------|---|--|
| 1. Vent/Air Conditioner Register  | 11. Auxiliary Generator Switch          | 21. Auxiliary Windshield Fan Switch    |
| 2. Left Turn Indicator            | 12. Audio Entertainment System*         | 22. Low Air Warning Light (Model 37RQ) |
| 3. Auxiliary Generator Hourmeter* | 13. Courtesy Lights Switch              | 23. Cigarette Lighter                  |
| 4. Vacuum/Fuel Economy Gauge      | 14. Aisle Light Switch                  | 24. Ignition Switch                    |
| 5. Instrument Cluster§            | 15. Map Light Switch                    | 25. Headlight Switch                   |
| 6. Battery Condition Meter        | 16. Beverage Tray Light Switch          | 26. ICC Courtesy Blink Switch          |
| 7. Right Turn Indicator           | 17. Check Engine•/Choke Indicator       | 27. Leveling Jacks Down Indicator      |
| 8. Heater A/C Controls*           | 18. Auxiliary Battery Disconnect Switch | 28. Fog Light Switch                   |
| 9. Battery Condition Switch       | 19. Rear Auto Heater Switch*            | 29. Remote Flood/Spotlight Control*    |
| 10. Battery Mode Switch           | 20. Exterior Compartment Light Switch   | 30. Air Horn Compressor Switch*        |

\* Optional

§ Refer to your vehicle chassis manual for functions and descriptions of these gauges.

• "Check Engine" segment not functional on California or Canadian equipped vehicles.

## INSTRUMENT PANEL - Elandan/Windcruiser (Optional Electronic Instrumentation)

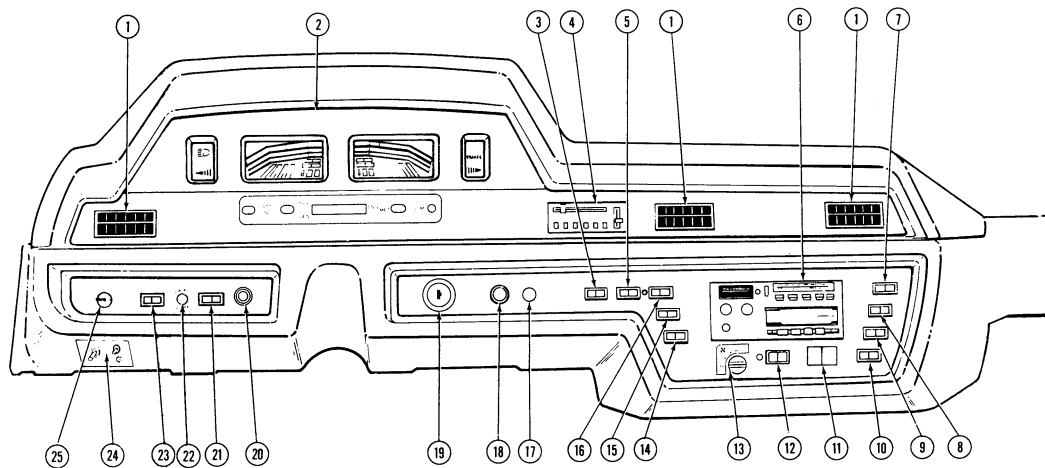

- |                                  |  |                                     |
|----------------------------------|--|-------------------------------------|
| 1. Vent/Air Conditioner Register | 10. Beverage Tray Light Switch           | 18. Cigarette Lighter               |
| 2. Instrument Cluster§           | 11. Check Engine●/Choke Indicator        | 19. Ignition Switch                 |
| 3. Battery Condition Switch      | 12. Auxiliary Battery Disconnect Switch* | 20. Headlight Switch                |
| 4. Heater A/C* Controls          | 13. Rear Auto Heater Switch*             | 21. ICC Courtesy Blink Switch       |
| 5. Battery Mode Switch           | 14. Exterior Compartment Light Switch    | 22. Leveling Jacks Down Indicator   |
| 6. Audio Entertainment System*   | 15. Auxiliary Windshield Fan Switch*     | 23. Fog Light Switch*               |
| 7. Courtesy Lights Switch        | 16. Auxiliary Generator Switch           | 24. Remote Flood/Spotlight Control* |
| 8. Aisle Light Switch            | 17. Low Air Warning Light (Model 37RQ)   | 25. Air Horn Compressor Switch*     |
| 9. Map Light Switch              |  |                                     |

\* Optional

§ Refer to "Electronic Instruments" in this section.

● "Check Engine" segment not functional on California or Canadian equipped vehicles.



**INSTRUMENT PANEL - ELANDAN/WINDCRUISER  
(Optional Electronic Display)**

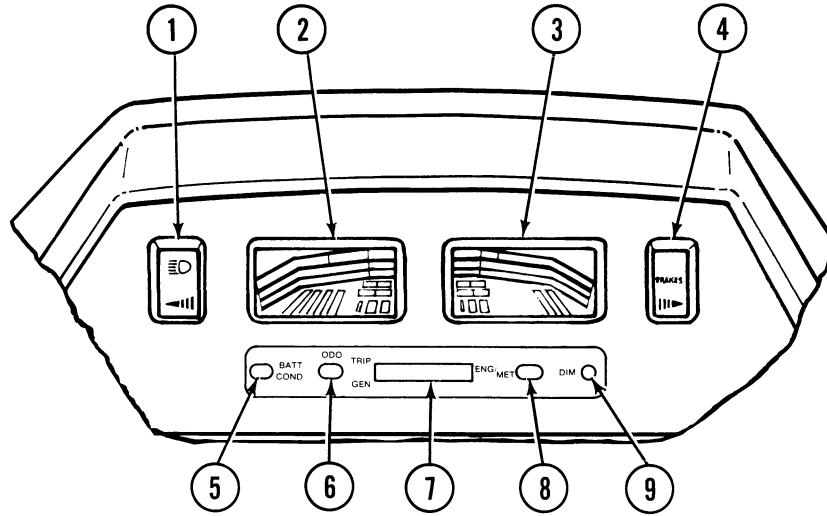

- |   |   |
|---|---|
| <ol style="list-style-type: none"> <li>1. Indicators: High beam and Left Turn</li> <li>2. Electronic Instrument Display - Left<br/>(See Descriptions on following pages)</li> <li>3. Electronic Instrument Display - Right<br/>(See Descriptions on following pages)</li> <li>4. Indicators: Brake Warning and Right Turn</li> <li>5. Battery Condition: Display Switch: Press once to monitor automotive battery voltage on the tachometer display. Press again to monitor auxiliary battery voltage. Press a third time to return to RPMs.</li> </ol> | <ol style="list-style-type: none"> <li>6. Odometer Display Switch: Press once to switch display from odometer to tripmeter. Press again to switch to generator hourmeter mode. Press a third time to return to odometer function.</li> <li>7. Odometer/Tripmeter/Hourmeter Display</li> <li>8. English/Metric (Miles/Kilometers) Switch</li> <li>9. Dimmer Control - Electronic Panel Lighting</li> </ol> |
|---|---|

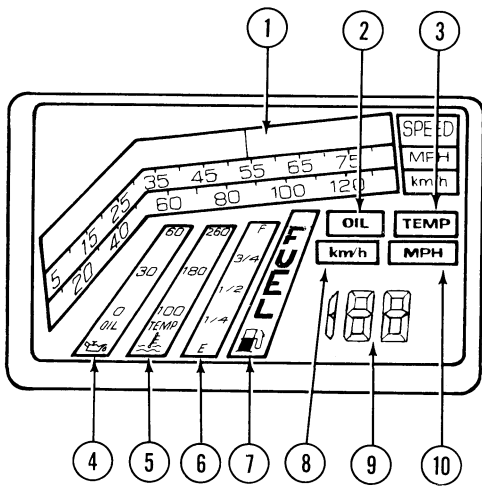

5. Engine Coolant Temp. Gauge - Displays coolant temperature from 100°F to 260°F. Thermometer symbol at bottom flashes if an error in the temperature monitoring system could render the gauge inaccurate or inoperable.
6. Fuel Gauge - Displays fuel tank level on bar graph.
7. Fuel Legend - Normally lit. Flashes if error in fuel measuring system could render the gauge inaccurate or inoperable. Small FUEL segment at top flashes when fuel tank level is approximately 1/4 tank or less.
8. km/h Mode Indicator - Lights when km/h mode is selected with the speedometer selector switch.
9. Digital Speed Display - Provides a digital read-out of speed in MPH or km/h as selected.
10. MPH Mode Indicator - Lights when MPH mode is selected with the speedometer selector switches.

**Descriptions - Left Instrument Display**

1. Speedometer - A bar graph displays speed in MPH or km/h, depending on the mode selected with the Speedometer Mode (MPH-km/h) Switch.
2. Oil Pressure Warning Indicator - Normally off. Flashes of oil pressure drops below 10 PSI.
3. Engine Temp. Warning Indicator - Normally off. Flashes if coolant temperature exceeds 220 degrees F.
4. Oil Pressure Gauge - Displays oil pressure from 0-60 PSI. Oil can symbol at bottom flashes if an error is detected in the oil pressure measuring system which could render the gauge inaccurate or inoperable.

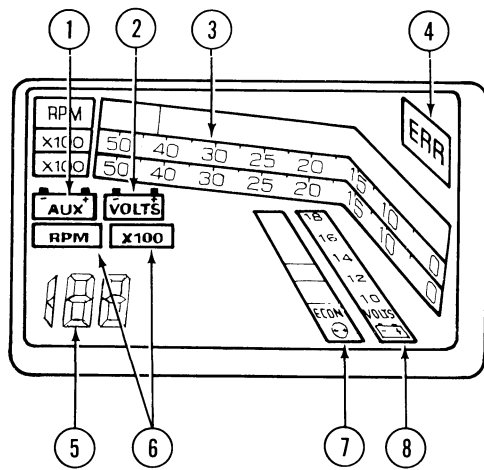

#### Descriptions - Right Display

1. Auxiliary Battery Indicator - Flashes if auxiliary battery voltage drops below 10.5 volts. This segment and the MAIN indicator will light while the Battery Condition Switch is in the AUX position. Auxiliary battery voltage will then appear on the digital tachometer display.
2. Main Battery Indicator - Flashes if main battery voltage drops below 10.5 volts. Lights while the Battery Condition Switch is in the MAIN position. Main battery voltage will then appear on the digital tachometer display.
3. Tachometer - Normally displays engine speed in RPM x 100, from 0-5500, on a graph corresponding to the selected speedometer mode. Before the engine has been started, it displays any existing sensor system error. (See Diagnostic Codes below) Also displays battery voltages when using the Battery Condition Switch.

4. System Error Indicator - Illuminates when a fuel, coolant or oil system sensor failure or wiring problem is detected while driving. No diagnostic code will be displayed until the vehicle is stopped. Turn the ignition switch off and then turn the key to the ON position. A diagnostic code will then be displayed. (See Diagnostic Codes below).
5. Digital Tachometer Display - While the engine is running the display indicates engine RPM x 100, from 0-5500. Indicates battery voltages while using the battery condition switch. Also displays a diagnostic code indicating any existing automotive system sensor error when the key is turned to the ON position before starting the engine. (See Diagnostic Codes below.)
6. Tachometer Mode Indicator - Normally illuminated. Blanks out while battery condition is being monitored.
7. Vacuum/Fuel Economy Gauge - Graph displays engine manifold vacuum as an indication of approximate fuel economy. The graph is divided into 3 sections; red for poor fuel economy, yellow for average, and green for good economy. The higher the reading, the greater the economy.
8. Aux. Battery Condition Gauge - Normally displays approximate voltage of the coach batteries. An accurate digital voltage also appears on the Tachometer display when selected with the "Batt. Cond." switch.
9. Main Battery Condition Gauge - Normally displays approximate voltage of the main (automotive) battery. An accurate digital voltage also appears on the Tachometer display when selected with the "Batt. Cond." switch.

## Diagnostic Codes

- F1:** Indicates a defective Main fuel tank sensor or loose sensor wire.
- F2:** Indicates a similar problem for the Auxiliary Fuel Tank.
- OL:** Denotes a defective oil sensor or loose sensor wire.
- IO:** Signifies a loose wire or defective ending temperature sensor.
- IS:** Also indicates a defective temp sensor or a grounded sensor wire.

## ELECTRONIC INFORMATION CENTER - Optional (Elandan and Windcruiser models only)

The Information Center is a small on-board time and mileage computer which can present a variety of useful information on its LCD display.

To select the display, press the desired function button at the right of the panel. The LED next to the button will light to indicate that mode is in use. The function buttons also double as number keys when setting the time, day and date, etc. Refer to the number which appears above or below each button.

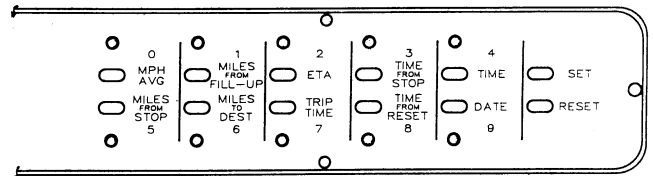
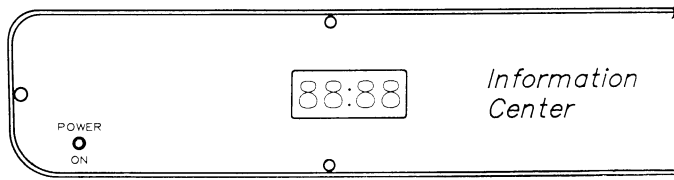

## Function Descriptions

The function of each button is described below. The number it represents in SET mode is shown ahead of the description.

- 0 - MPH AVG: Displays average speed since the last reset. The display registers to the nearest 1 mph and is updated every 5 seconds at speeds above 5 mph.

To Reset: Press the RESET button while in MPH AVG mode.

NOTE: You may wish to reset average speed after entering Miles to Destination, since ETA is based on average speed when the vehicle is traveling less than 30 mph.

- 1 - MILES FROM FILL-UP: This function must be manually reset after filling fuel tanks. Press the button to display accumulated miles since last reset. To Reset: Press MILES FROM FILL button, then RESET button.
- 2 - ETA: Shows estimated driving time of arrival at destination at current vehicle speed. (At speeds below 30 mph, the computer calculates ETA using average mph.) When ETA is less than 100 hours, the display is HR:MN. If ETA exceeds 100 hours, the display will list hours only (to a maximum of 9999 hrs.).
- 3 - TIME FROM STOP: Shows driving time, above 5 mph, since the engine was last started. This time is automatically cleared each time the engine is started.

- 4 - TIME: Press this button to display current time. The display is automatically in TIME mode when the vehicle is started. To Set the Time:
  - press SET button
  - enter proper time using number buttons
  - press SET button to select AM or PM (A or P)
  - press RESET button to end setting procedure
- 5 - MILES FROM STOP: In this mode, the display will show accumulated miles since the engine was last started. This number is automatically cleared each time the engine is started.
- 6 - MILES TO DEST: Displays the miles remaining to your destination. You enter the total miles to your destination into the computer before departing and each mile you travel is subtracted from that total. To Enter Miles to Destination:
  - press DEST button, then SET button - display will show 0 mi.
  - using number buttons, enter distance to destination (not to exceed 9999)
  - press RESET to end setting procedure and begin count-down.
- 7 - TRIP TIME: Shows total driving time above 5 mph since the TRIP ODO was last cleared, displayed in HR:MH. This feature is automatically reset when the TRIP ODO is reset. (See Optional Electronic Display).
- 8 - TIME FROM RESET: Press this button to display driving time (how long the ignition switch has been on) since last reset of this function. To Reset: Push RESET while in Time From Reset mode.
- 9 - DATE: Continuously displays the month and day. To Set the Date:
  - press SET button
  - enter desired date using number/function buttons
  - press RESET to end setting procedure

SET: Pressing this button places the clock module in SET mode to program the time and date. The number shown above or below each function button will be entered on the display when that button is pressed.

RESET: Press to reset displayed function.

**IMPORTANT**

Be sure that the proper function is in use before pressing this button to avoid accidental erasure of information you wish to keep.



## SECTION 9: CARE AND MAINTENANCE

### CAUTION

Sealants must be inspected every 6 months and resealed if necessary.

#### ROOF

The roof utilizes Thermo-Panel® construction like the walls and floor. It will support the weight of an average adult should it become necessary to repair the roof or roof mounted components. It is not recommended, however, that very large or heavy objects be carried on the roof while the vehicle is in motion. Always have damage to the roof area repaired immediately. Damaged or detached sealant around the vents, air conditioner, body-to-roof seams, etc., should also receive immediate attention. Delaying these repairs may allow water leakage and result in damage to interior ceiling and body panels, upholstery, etc.

#### UNDERBODY

Buildup of mud under the body can not only cause rust, but add unnecessary weight which contributes to the gross weight of the vehicle. This, in effect, reduces the amount of cargo you can carry and remain within GVWR and GAWR limits.

Corrosive materials, such as those used for ice and snow removal and dust control, also accumulate on the underside of a vehicle. These materials should be removed by flushing the underbody regularly with water, especially areas where mud and other foreign materials collect.

#### EXTERIOR

The exterior surface of your motor home has an automotive finish. Frequent washing and thorough cleaning is recommended to prevent damage to the vehicle finish after exposure to damaging salts, calcium chloride, road tar, tree sap, insects and other foreign material. Never wash the vehicle in direct sunlight, while the vehicle surface is hot, or using hot water.

Do not use strong soaps or detergents for washing the motor home. Always use a mild soap in warm water, a commercially prepared product for cleaning automotive finishes or your local car wash.

After washing the motor home, carefully inspect caulking around window frames and vents and any other joints that may have separated. Re-caulking, if necessary, is quite simple. Appropriate compounds are sold at Winnebago/Itasca dealers, and the materials are quickly and easily applied. Also, inspect weather seals around door, etc., and if necessary have a dealer replace them immediately.

## CAUTION

Never use a strong solvent such as lacquer thinners or harsh abrasives on painted surfaces.

It is recommended that a coat of automotive wax be applied to the surface occasionally to provide added protection against harmful deposits coming in contact with the paint.

## UPHOLSTERY, CARPETING AND DRAPERIES

### Upholstery and Carpeting

We recommend a weekly routine of vacuuming all fabrics and carpet throughout the motor home. This will prevent an accumulation of soil which can detract from the appearance and shorten the life of carpet and fabrics.

Some fabrics used in this motor home are treated with flame retardant and lightfastness additives which can be damaged by use of improper cleaning agents. Some water-based household cleaning agents are not formulated for use on fabrics and may cause excessive shrinkage or fading. For best results, fabric cleaning should be referred to a professional carpet and upholstery cleaning service.

### IMPORTANT

**To minimize fading of upholstery, carpets and other interior fabrics caused by excessive sunlight, the drapes, blinds or shades should be closed when the motor home is parked for an extended period of time.**

## WARNING

When cleaning upholstery, carpeting and fabric, do not use lacquer thinner, nail polish remover, laundry soaps, or bleach. Never use carbon tetrachloride, gasoline, or naphtha for any cleaning purpose. These materials may cause damage to the material being cleaned and most are highly flammable.

### Spots and Stains

Spots or stains should be treated as soon as possible before they "set in" to avoid permanent damage. For best results, follow the items listed below and always follow the directions on the cleaning agent label.

1. Test any cleaning agent on a hidden area of fabric before using on visible areas.
2. Use a clean cloth or sponge and turn frequently to an unused area of the cloth or sponge as you clean.
3. Start from the outside of a spot or stain and work inward to avoid spreading or leaving a "ring".
4. Stains or soils, such as lipstick, ink, grease or mustard, are extremely difficult or impossible to remove completely and should receive immediate attention. Consult a professional carpet and upholstery cleaning service for assistance.



### **Vinyl**

Vinyl should be cleaned with a soft, damp cloth and a mild detergent only. Do not use solvents. Solvents may damage the surface of the vinyl.

### **Draperies, Curtains and Bedspreads**

These items may be woven from a variety of fabrics. We recommend that these be professionally dry cleaned only. A five percent shrinkage may occur when you have these items dry cleaned.

### **TABLES AND COUNTERTOPS**

Work surfaces are covered with a plastic laminate that is resistant to solvents, stains and abrasions. A coat of furniture wax applied to these surfaces on the counters and table will help preserve their beauty and make cleaning easier. Always clean the surface before applying wax.

### **STAINLESS STEEL SINK**

The stainless steel sink can be cleaned with soap or detergent. Rinse thoroughly with warm water and wipe dry to avoid streaks.

Use a mild abrasive for stubborn stains. Work in the direction of the polish lines. To keep the original finish, polish with a wax cleaner and rub with a soft dry cloth.

## **WARNING**

Salt, mustard and mayonnaise may cause pitting. If spilled, clean immediately.

### **RANGE AND REFRIGERATOR**

For care and appearance maintenance of the range and refrigerator, refer to the operation and maintenance manual for each of the individual appliances included in your Owner's Information Packet.

### **BATHROOM**

The shower walls in the bathroom should be cleaned with a mild soap and water solution or (to obtain maximum luster), use a good quality wax cleaner. Do not use an abrasive cleaner on the shower walls. However, a mild abrasive cleaner may be used to clean the shower floor or bathtub. If the shower has a Plexiglass door, it is extremely important that abrasives not be used. Solvents and aromatic spirits that contain a petroleum base or additive should also not be used. These products can cause a reaction with the glass that results in visible deterioration marks. Use only a mild detergent and water solution with a soft cloth to clean Plexiglass surfaces.

The bathroom lavatory is also a molded plastic material and should be cleaned with a mild soap and water solution. Abrasive cleaners or harsh detergents should not be used.

For instructions on the care of the fresh water toilet, refer to the information in your Owners Information Packet.

### **DOORS AND WINDOWS**

Windows may be periodically cleaned with a good quality glass cleaner or mild soap solution using a soft cloth. Use care when removing ice or frost from the windows. Always use a plastic ice scraper, never one made of metal. Use care when removing ice from the mirrors to protect the reflective surfaces.

Door locks and hinges should be lubricated periodically with powdered graphite to ensure trouble-free operation and to protect against freeze-up.

# VEHICLE MAINTENANCE

(See also Safety Precautions, Section 1 of this manual).

## CHASSIS SERVICE & MAINTENANCE

Consult the appropriate sections in your vehicle chassis manual for specific information regarding operating safety, service recommendations and maintenance schedules for the chassis section of your motor home.

## ENGINE ACCESS (C-Body)

Hood release locations and directions are given in your vehicle chassis manual.

### IMPORTANT

When closing the hood, push down firmly to ensure that it latches properly and test by attempting to pull up on it.

### Engine Cover

The engine cover, located in the driver's compartment, is retained by two latches at the forward end and with screws at the floor area. Access to the air cleaner and other engine parts can be gained through this opening.

## ENGINE ACCESS (A-Body Motor Homes)

### Hood

The hood release lever is located on the steering column bracket near the bottom of the dash. To open, pull out on the knob and the hood will pop open. Lift up the hood and secure it with the hood support rod.

With the hood open, the oil dipstick, oil fill, radiator fill, power steering reservoir and windshield washer reservoir are accessible. On Elandan and Windcruiser, the automotive battery is also accessible.

### IMPORTANT

When closing the hood, push down firmly to ensure that it latches properly and test by attempting to pull up on it.

### Engine Cover

Remove the four (4) bolts securing the engine cover to the floor of the driver's compartment and lift cover off to gain access to engine.

Removal of the engine cover allows access for servicing the transmission dipstick and fill tube, engine air cleaner and other engine parts.

## ENGINE OIL

### Checking Oil Level

Engine oil must be maintained at the proper level. Refer to engine manufacturer's recommendations found in your vehicle chassis manual.

## BRAKE FLUID RESERVOIR (A-Body Motor Homes)

Access to the brake fluid reservoir is located under the left front wheel well. To check the fluid level, turn the front wheel completely to the left; the reservoir is just above and ahead of the left wheel.

### **BRAKE MASTER CYLINDER (All A-Body Motor Homes)**

The brake master cylinder is located on the chassis frame under the left front wheel well and is covered by a metal shield for protection against road debris.

### **ENGINE COOLING SYSTEM**

Refer to your vehicle chassis manual for information and precautions regarding coolant system capacities, filling, servicing and fluid level inspection.

### **CAUTION**

When refilling the coolant system of a vehicle with a rear auxiliary automotive heater and motoraid water heater, be sure to allow for additional coolant capacity of the heater and its supply and return hoses.

### **TIRES**

Low air pressure results in tire overloading and abnormal wear and also affect handling and fuel economy. Proper inflation pressures may be obtained from your vehicle chassis manual or tire manufacturer.

### **WARNING**

Radial ply tires are optional on some models. The tire option is not intended to upgrade the load rating of the entire vehicle and does not imply that GVWR and GAWR ratings may be increased over the figures found on the certification label.

Make sure all replacement tires are of the same size and ply rating as those installed as original equipment.

### **SUSPENSION ALIGNMENT AND TIRE BALANCE**

The front suspension and steering system of this vehicle was factory aligned using highly accurate equipment prior to delivery to the dealership. However, we recommend that alignment be checked and, if necessary, adjusted after the owner has fully loaded the motor home according to his needs. Thereafter, the alignment should be periodically inspected to help prevent uneven tire wear.

Any excessive or abnormal tire wear may indicate worn or misaligned suspension or steering, unbalanced tire or other tire/suspension problem.

Alignment can be affected by worn steering/suspension parts or by incidents which happen during driving, such as hitting a curb, pothole or railroad track, etc. Improper alignment can cause tires to roll at an angle and wear unevenly. It may also cause the vehicle to "pull" to the right or left. Have your dealer inspect your vehicle's suspension and steering components periodically for misalignment or wear.

Out-of-balance tires will not roll smoothly and can lead to annoying vibrations and uneven tread wear such as cupping and flat spots. Tires may need to be balanced if uneven wear is detected or if ride comfort decreases noticeably.

#### CARE OF OPTIONAL ALUMINUM WHEELS

If your aluminum wheels should become dull or discolored by road film, use any commercially available designated aluminum wheel cleaner/polish to restore the bright finish. The wheel manufacturer suggests monthly cleaning during constant daily use and less frequently with decreasing use.

### MOTOR HOME JACKING AND TIRE CHANGE PROCEDURE (A-Body)

#### IMPORTANT

The jack referred to in the following instructions is not supplied with the vehicle and must be obtained by the owner from the selling dealer.

The jack is designed for use as a tool for changing tires only, not for use as a leveling device or as a support for service purposes.

## WARNING

Tire change procedures should be used in emergency situations only. The operator is advised to obtain qualified road service when possible.

### SAFETY PRECAUTIONS

Before attempting to change either the front or rear tires, the following precautions should be adhered to:

1. Park vehicle on level surface only.
2. Turn off engine and set parking brake.
3. Activate hazard warning flasher.
4. Block both front and back of wheel opposite wheel to be removed.
5. On soft ground, use a board or other material under jack as a firm base to ensure that the jack will not shift.

#### JACKING POINT ON VEHICLE

MODELS	FRONT	REAR
All	Lower Control Arm	Under Axle Housing Near Wheel to be Raised

#### Front Wheel

Before attempting to remove the front wheel, observe the above safety precautions, then initiate the following procedures:

1. Turn the jack extension out to approximately ground to spring height.
2. Position jack under lower control arm.

NOTE: Lower control arm base must be supported by the jack. Begin jacking until the jack is firmly positioned, but do not jack tire off the ground.

3. Loosen wheel nuts with lug wrench.
4. Resume jacking until wheel is free of ground.
5. Remove wheel nuts and wheel; put spare wheel in place.
6. Install wheel nuts and tighten as much as possible with wheel and tire off the ground.
7. Lower tire until tire just contacts the ground. Tighten nuts with lug wrench in recommended sequence.
8. Finish lowering jack, remove jack and blocks.

## WARNING

Upon satisfactory completion of emergency tire change, it is highly recommended that wheel nuts be properly torqued and inspected by qualified service personnel as soon as possible.

### Dual Rear Wheels

Before attempting to remove the rear wheel, follow safety precautions in the beginning of the motor home jacking procedures and then initiate the following procedures.

1. Turn jack extension out to approximate ground axle housing tube height.
2. Place jack under axle housing near wheel to be raised. Center jack on the housing so vehicle will not slide off jack. Place jack far enough inboard on the axle housing so that when the handle is inserted, the jack may be operated from either in front or behind the tire without crawling under the vehicle.
3. Begin jacking, but **DO NOT** lift wheel and tire off the ground.
4. Loosen wheel nuts with lug wrench.
5. Resume jacking until wheel and tire are free of ground.

**NOTE:** Full torque must be applied to dual rear wheel nuts with both wheels off the ground.

## WARNING

**DO NOT** crawl under the vehicle when it is supported by a jack.

6. Remove wheel nuts and wheel.

### IMPORTANT

When installing the outboard wheel and tire assembly, rotate the wheel so that an outboard wheel cutout, without the tire valve, is opposite the inboard wheel tire valve.

7. Mount spare wheel on studs and replace wheel nuts. Refer to your vehicle chassis manual for wheel nut torque and tightening sequence.

**NOTE:** When installing or tightening dual wheels, both wheels on the same side must be off the ground (not resting on the inner dual). This minimizes the possibility of loose wheels after correct mounting torque is applied.

### Wheel Nuts

To properly seat the wheel nuts and to eliminate the possibility of the wheel nuts becoming loosened while driving, they should be tightened at frequent intervals to the torque specified in your vehicle chassis manual.

## WARNING

The operator is advised to obtain road service whenever possible and attempt tire changing under emergency conditions only and with close adherence to instructions. If it becomes necessary to change a wheel, that wheel should be checked, after being properly torqued and inspected by qualified service personnel, at 100 miles and every oil change thereafter.

Upon satisfactory completion of emergency tire change, it is highly recommended that the wheel nuts be properly torqued and inspected by qualified service personnel as soon as possible.

## WARNING

Do not use wheel nuts intended for aluminum wheels to mount the steel wheel spare tire. These nuts will not seat properly on steel wheels. Use only the wheel nuts and steel clamp ring provided with the spare tire for mounting.

### RECOVERY TOWING

#### All C-Body Vehicles

Consult your vehicle chassis manual for proper emergency towing procedures.

#### Vehicles with John Deere Chassis Only

Consult your John Deere vehicle chassis manual regarding instructions for emergency towing. Due to the automatic parking brake feature on this chassis, special towing procedures must be followed.

#### Elandan or Windcruiser with Soft Front Bumper

## CAUTION

The ABS plastic front bumper facia must be removed before towing to avoid cracking or other damage.

The front bumper facia (shell) is attached to the bumper structure and fenders at the locations shown.

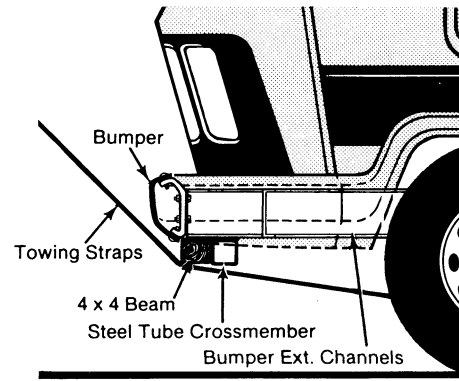
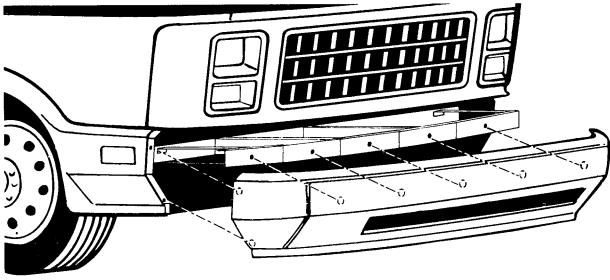

After removing the bumper facia, follow the A-Body towing procedures below.

### **A-Body Motor Homes (Except John Deere Chassis)**

Correct preparation is required to avoid damage to the bumper and/or front end of the motor home.

1. Remove any equipment that may interfere with a towing sling, such as fog lights or driving lights, etc. Place padding (heavy cloth or carpeting) between bumper and sling to avoid marring the bumper finish. (Owners of Elandan 37RQ or Windcruiser 37RQ refer to preceding CAUTION.)
2. Position tow hooks where they cannot damage brake lines.
3. Do not attach tow hooks to the bumper, bumper brackets, steering and suspension components, brake components or sway bars.

4. Place a 4" x 4" (minimum) wooden or metal beam across both bumper extension channels forward of the steel tube crossmember as shown. (Not required for vehicles with metal bumper.)
5. Make sure towing straps do not come in contact with the bumper or motor home front end.
6. Use a safety chain system that is completely independent of the primary lifting and towing assembly.
7. Secure any loose or protruding parts of damaged vehicles before towing.

## **WARNING**

Stay out from under the motor home when it is suspended by the towing assembly unless the unit is adequately supported by safety stands. Do not allow passengers to ride in a towed unit.

### **IMPORTANT**

Be familiar with and observe all state and local towing regulations.

## **CAUTION**

Make sure wrecker straps do not come in contact with bumper. **DO NOT LIFT ON BUMPER!**

### **AIR SPRINGS - Rear (A-Body only)**

Some models may be optionally equipped with pneumatic air bag rear helper springs. The fill valve(s) for these springs are located on the valance panel, near the rear tires, on either side of the vehicle.

Air pressure must be maintained at a minimum of 20 psi and a maximum of 90 psi. Detailed information regarding adjustment of air springs is provided in your Owner Information Packet.

### **AIR SPRINGS - Front (A-Body Chevrolet only)**

Consult your vehicle chassis manual for correct air pressure recommendations.

### **REAR SUSPENSION INFORMATION (Elandan/Windcruiser Model 37RQ only)**

The rear suspension system consists of an adjustable, air spring suspended drive axle and an independent, torsion sprung, trailing arm tag axle which assists, and to a large degree controls the performance of the drive axle. The tag axle maintains a constant, preset weight load throughout the entire load range of the vehicle. This helps to minimize body roll, leaning and rear end sag.

#### **In Case of Temporary Traction Loss**

Should an uneven surface (such as a driveway entry) cause the drive wheels to lose contact with the drive surface, you may experience a momentary loss of mobility. In this event, remove your foot from the accelerator and allow approximately 8-12 seconds for the axle system to adjust itself and restore traction.

**NOTE:** If the distance from the drive wheels to the drive surface is beyond the adjustment capability of the system, towing assistance may be required.

#### **Compressor Operation**

The compressor, which is located under the lavatory area, will operate periodically to maintain pressure in the air reserve tank. A brief "hiss" sound may be heard as the compressor stops and when the ignition is switched off. This is a normal pressure bleed-off function of the compressor and is no cause for alarm.



### Moisture Purging

The air tank is mounted on the underside of the vehicle between the rear axles and the fuel tank. A drain valve is mounted on the bottom of the air tank to allow you to purge the condensation that normally forms on the inside of the tank.

The valve is operated by pulling a metal ring on a cable which is attached to the valve. The ring is suspended from the chassis rail near the sewage dump valves on the rear left side of the vehicle.

To purge moisture from the air tank, pull on the metal ring momentarily and release repeatedly until water is no longer seen spraying from the valve on the bottom of the tank. This operation should be performed weekly during periods of normal use.

### CAUTION

The LOW AIR warning light, located on the instrument panel, will illuminate if a failure should occur in the tag axle/rear suspension system. If this should occur while driving, the vehicle may be carefully driven to the nearest Winnebago dealer or a qualified truck air suspension service center. Although this condition does not totally disable the vehicle, it will cause less than satisfactory ride characteristic and should be serviced as soon as possible to restore proper performance.

### Lubrication and Maintenance

The tag axle bearings require annual and periodic maintenance as described below to ensure maximum performance and durability. Service is required at more frequent intervals for severe operating and climate conditions.

### WARNING

Failure to correctly maintain proper lubrication in the bearings may result in bearing damage, which could cause the wheel to seize or become detached during operation.

**Periodically** - Using a manual grease gun, add 2-3 strokes of lithium base wheel bearing grease through the zerk fitting in the center of the tag bearing dust caps. This should be performed at regularly scheduled intervals, such as oil changes or chassis lubrications.

**Yearly** - Bearing components should be inspected at each 12,000 miles or at least annually, especially when returning vehicle to service after storage periods, to ensure that no abnormal wear or bearing setting has resulted. Repack bearings, cups and dust covers with lithium base wheel bearing grease and reinstall assembly. Due to the critical nature of wheel bearing adjustment, we recommend that this operation be performed by your dealer.

**FRONT BUMPER - Elandan/Windcruiser  
(Except models 26ET and 28EU)**

**CAUTION**

Do not stand on or mount objects to the front bumper shell. This could cause damage to the appearance of the plastic shell.

The front bumper of this vehicle is equipped with a color keyed shell made of high-impact ABS plastic. Standing on the bumper, however, to wash the windshield or to perform other services is not recommended. This could cause damage to the decorative finish or possibly crack the shell. We recommend using a step ladder or foot stool to gain the required height for these tasks.

**WINDSHIELD WASHERS AND WIPERS**

See your vehicle chassis manual for recommendations and precautions regarding washers and wipers.

**LIGHTS**

All exterior lights should be checked for proper operation each time the vehicle is prepared for a trip. Any bulbs which fail to light should be checked and replaced, when necessary, with a new bulb of the same size. A failure of more than one light, such as both taillights not operating, may indicate a burned-out fuse. Check fuse and replace with one of the same rating when necessary. If a fuse is not the cause of the problem, the wiring system should be checked immediately by an authorized service center.

The headlight circuit is protected by a circuit breaker. An overload on the breaker will cause the lights to flicker on and off. Headlight wiring should be checked immediately anytime this condition is apparent. Refer to your vehicle chassis manual for further information.

**FUSES**

The automotive electrical circuits and accessories in your motor home are protected from short circuits and overload conditions by a fuse block. This block is located behind a panel beneath the radio on Chieftain/Sunflyer, and beneath the dash to the left side of the steering column on all other models. See your vehicle chassis manual for additional fuse replacement information.

## SECTION 10: SEASONAL STORAGE AND PREPARATION

Your motor home is equipped with many vital systems that may be damaged due to improper storage or freezing conditions. Therefore, it is crucial to have your vehicle properly prepared for prolonged storage.

Proper winter storage procedures will lessen the possibility of costly repairs, assure the vehicle's reliability, and provide continued motor home enjoyment.

After each use, it is advisable to prepare the motor home for vacancy just as you would if you left your house or apartment for a period of time. Make sure all perishables have been removed from the cabinets and refrigerator. Also, make sure that proper ventilation has been provided. Always check to ensure that the LP gas tank has been turned off. It is advisable to drain the water heater, water tank and holding tanks. Close the shade to protect upholstery from direct rays of the sun.

When preparing the vehicle for winter storage in cold climates, it is extremely important that all winterizing steps be performed.

### WINTERIZING

The objective in winterizing the motor home is to protect the various components and systems against damage from freezing. The most vulnerable areas are the water system, drainage system, water heater and batteries. Perform each of the following steps to ensure that each system has been completely drained or protected.

It is also important to wash the exterior of your motor home before storage. After washing the motor home, carefully inspect the seams and caulking around window frames, vents and any

other joints that may have separated. Re-caulking, if necessary, is quite simple. Appropriate compounds are sold at Winnebago/Itasca dealers and the material is quickly and easily applied. Also, inspect weather seals around doors, windows, etc., and if necessary have a dealer replace them immediately.

1. Level the motor home and turn off LP tank valve.
2. Remove all foods and equipment that may cause odors.
3. Clean entire vehicle. Dirt and stains are more easily removed when fresh.
4. Close all windows and roof vents.
5. Drain the complete water system.
  - A. Open all needle valves by pulling up on a "T" handle or ring.

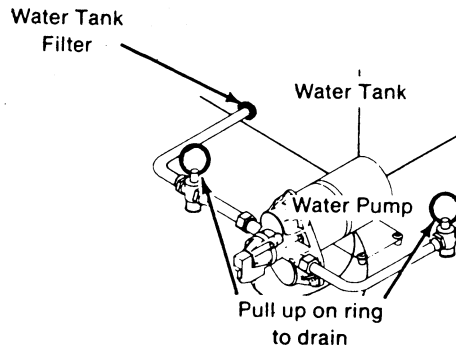

- B. Open all faucets and the shower head.
- C. Allow demand water pump to operate until all water lines have been drained.
- D. With water pump running, operate toilet flush mechanism and hold until water stops flowing.
- E. Drain water heater by opening drain valve located at base of water heater tank and accessible from the outside of the motor home. Also open the pressure relief valve, located at the top right portion of the tank. This will assist the draining and prevent air locking in the tank.

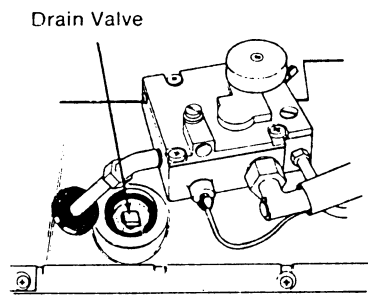

**Water Heater Drain Valve**

- F. Disconnect discharge and intake water lines from demand water pump. Start pump and allow to run until all water has been expelled from the unit (Running dry will not harm the pump). Then reconnect the lines.
- G. Pour dealer recommended non-toxic antifreeze into the bathroom sink drain, shower drain and kitchen sink drain(s).

**NOTE:** As an alternative to system draining, all tanks and lines may be winterized with the use of non-toxic antifreeze added to the storage tank and pumped throughout the system. Follow the directions on the container to determine the correct amount of antifreeze to be used.

## WARNING

Do not use automotive type radiator antifreeze; it is poisonous.

- 6. Completely drain both the waste water and sewage holding tanks. Thoroughly rinse tanks and drain again. It is recommended that when rinsing the tanks, the vehicle be driven a few blocks, or alternately accelerate and apply brakes to make sure all material has been loosened. Close the dump valves and replace cap to prevent the dump valve shafts from rusting and to prevent rodents from entering the tank.
- 7. Turn furnace thermostat to "Off" position.
- 8. Lubricate all hinges and door locks.
- 9. Clean and defrost refrigerator. Leave door slightly ajar.
- 10. Seal all appliance vent openings.
- 11. Have chassis completely lubricated.
- 12. Disconnect battery cables from all batteries. (The Auxiliary Battery Disconnect System may be used to disconnect coach batteries for storage, if so equipped. See instructions in Section 3 of this manual.)
- 13. In areas where freezing temperatures occur, the batteries should be removed from the vehicle and stored indoors whenever possible. When they are left in the vehicle, the

state of charge of all batteries must be checked regularly. A battery will discharge by itself in time, and a battery with one half charge or less may freeze. Since the discharge time varies with temperature, battery age and other conditions, batteries should be checked at least every two weeks.

14. Make sure antifreeze level in the automotive radiator is sufficient to protect against freezing at the lowest anticipated temperature.
15. Winterize the fresh water toilet by one of the following methods.
  - A. Disconnect the water line at the toilet inlet. Depress the foot pedal and insert an object, such as a wedge-shaped block of wood or similar object, into the outlet at the bottom of the bowl.

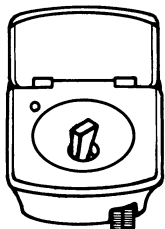

#### **IMPORTANT**

Avoid using items small enough to drop through outlet into tank.

- B. Use non-toxic antifreeze to winterize the entire motor home fresh water plumbing system. Follow the directions on the antifreeze container.
16. Prepare the optional 110 volt generator for storage by following the instructions given in the generator manual supplied in your Owner Information Packet.

#### **REMOVAL FROM STORAGE AND NEW SEASON PREPARATION**

1. Completely ventilate the motor home.
2. Check the entire LP gas system and appliances for leaks using the leak detector.
3. Check window operation.
4. Check cabinet and door hinges. Lubricate with penetrating oil, if necessary.
5. Close all faucets and drain valves that are open. If necessary, reconnect toilet water line and close flush valve.
6. Fill water tanks and check for leaks especially at junctions. Also make sure all hangers and supports are securely in place. Sanitize the water system as outlined under "Sanitizing the Potable Water System" in Section 4.
7. Check operation of all faucets to be sure faucet washers have not hardened during storage.
8. Check sealing valve in the toilet for proper operation and lubricate with silicone spray.
9. Add water to the holding tank and check to be sure dump valves seal tightly.
10. Check around all appliances for obstructions and ensure that all vent openings are clear.
11. Start refrigerator and check for proper cooling.
12. Clean paneling and counter surfaces and apply a thin coat of furniture wax.
13. Replace batteries if necessary and check out electrical system to make sure all lights and electrical components operate.
14. Check tires for proper cold inflation pressure.
15. After washing accumulated grime from the motor home, carefully inspect the seams and caulking for cracks that

may have appeared around window frames and vents and any other joints that may have separated. Re-caulking, if necessary, is quite simple. Appropriate compounds are sold at Winnebago/Itasca dealers and the material is quickly and easily applied. Also, inspect weather seals around doors, etc. and, if necessary, have a dealer replace immediately.

16. Check smoke detector operation, if so equipped.

## WATER SYSTEM DRAIN VALVE LOCATIONS

MODEL	DRAIN VALVE LOCATIONS
Minnie Winnie 319RB or RK Sundancer 319RB or RK	Beneath front dinette seat; beneath rear wardrobe cabinet; beneath water heater.
Minnie Winnie 420RG Sundancer 420RG	Beneath shower tub (behind access panel); beneath water tank in bottom of refrigerator cabinet compartment.
Minnie Winnie 421RB Sundancer 421RB	Beneath range; beneath shower tub (behind access panel); beneath rear dinette seat
Minnie Winnie 424RC Sundancer 424RC	Beneath shower tub (behind access panel); beneath rear dinette seat
Minnie Winnie 424RB Sundancer 424RB	Beneath shower tub (behind access panel); beneath ice maker (optional)
Minnie Winnie 426RT Sundancer 426RT	Beneath shower tub (behind access panel); beneath right twin bed or right side of double bed
Chieftain 22RC Sunflyer 22EC	Beneath water tank under wardrobe, beneath shower tub (behind access panel)
Chieftain 27RU Sunflyer 27RU	In bottom refrigerator cabinet compartment; beneath lavatory shelf access panel.
Chieftain 27RT Sunflyer 27RT	Behind shower tub access panel; beneath rear of double bed or beneath left and right twin beds.

### WATER SYSTEM DRAIN VALVE LOCATIONS (CONT.)

MODEL	DRAIN VALVE LOCATIONS
Chieftain 31RT Sunflyer 31RT	Beneath galley; beneath shower tub (behind access panel); beneath ice maker (optional)
Chieftain 33RU Sunflyer 33RU	Beneath lavatory; beneath shower tub access panel; behind access door under left wardrobe; beneath ice maker (optional)
Superchief 27RQ Suncruiser 27RQ	In-line on both sides of demand pump (located in compartment forward of passenger-side rear wheels.)
Superchief 31RQ Suncruiser 31RQ	Beneath shower tub (behind access panel); In-line on both sides of demand pump (located in compartment to rear of driver side).
Superchief 34RQ Suncruiser 34RQ	Beneath passenger-side twin bed; In-line on both sides of demand pump (located in compartment to rear of driver side).
Elandan 26ET Windcruiser 26ET	Beneath right twin bed or right rear of queen bed; beneath galley.
Elandan 28EU Windcruiser 28EU	Beneath rear bed; beneath shower tub (behind access panel); beneath galley cabinet shelf
Elandan 32RQ Windcruiser 32RQ	Beneath galley, beneath lavatory cabinet, beneath ice maker (optional)
Elandan 34RU Windcruiser 34RU	Beneath rear bed; beneath shower tub (behind access panel); beneath ice maker (optional)
Elandan 37RQ Windcruiser 37RQ	Beneath queen bed; beneath wardrobe; beneath ice maker (optional)



# IMPORTANT SERIAL NUMBERS

You will want to make a record of all serial numbers for future reference. Look for them and fill in immediately.

Motor Home Serial Number \_\_\_\_\_

Chassis Serial Number \_\_\_\_\_

Air Conditioner Serial Number \_\_\_\_\_

Range Model and Serial Number \_\_\_\_\_

Refrigerator Model and Serial Number \_\_\_\_\_

Furnace Model and Serial Number \_\_\_\_\_

Water Heater Model and Serial Number \_\_\_\_\_

Converter Model and Serial Number \_\_\_\_\_

Optional 110-Volt Generator Model and Serial Number \_\_\_\_\_

When writing to Winnebago Industries, Inc., be sure to include your motor home serial number and chassis number. When writing to a component manufacturer for information, be sure to include the model and serial number for that item.

# EMERGENCY INFORMATION

## Dealer

Name \_\_\_\_\_

Address \_\_\_\_\_

Phone \_\_\_\_\_

## INSURANCE POLICY

Company \_\_\_\_\_

Policy Number \_\_\_\_\_

Phone \_\_\_\_\_

## INDEX

- A**
- AC Electrical System, 110 Volt . . . . . 3-1
  - Air, in LP Tank . . . . . 2-3
  - Air Conditioner, Auto . . . . . 8-2, 8-3
  - Air Horns . . . . . 8-5
  - Airlift Sensoride . . . . . 8-7
  - Air Springs (Suspension) . . . . . 9-10
  - Aisle Light Switch . . . . . 8-5
  - Aluminum Wheels, Care Of . . . . . 9-6
  - Armrests, Adjustment . . . . . 8-15
  - Auxiliary Battery Disconnect Switch . . . . . 3-9
  - Auxiliary Fan Switch . . . . . 8-5
  - Auxiliary Generator
    - Hourmeter . . . . . 3-12
    - Operation and Care . . . . . 3-13
    - Remote Switch . . . . . 3-12
- B**
- Bathroom, Care Of . . . . . 9-3
  - Batteries
    - Access . . . . . 3-5, 3-6
    - Condition Meter . . . . . 3-8
    - Disconnect Switch . . . . . 3-9
    - Isolator (Diesel Only) . . . . . 3-11
    - Maintenance . . . . . 3-7
    - Switch, Dual . . . . . 3-8
  - Bearings, Tag Axle . . . . . 9-11
  - Beverage Tray Light Switch . . . . . 8-5
  - Brake Fluid Reservoir . . . . . 9-4
  - Brake Master Cylinder . . . . . 9-5
  - Bulk Tank, LP Gas . . . . . 2-2
  - Bumper, Front (Model 37RQ) . . . . . 9-8, 9-9
  - Bunks, Front Overhead . . . . . 6-1
- C**
- Carbon Monoxide Warning . . . . . 1-4
  - Carpeting, Care Of . . . . . 9-2
  - Child Restraints . . . . . 8-12
  - Coach Leveling Systems . . . . . 8-6
  - Compartment Light Switch, Exterior . . . . . 8-5
  - Converter, Power . . . . . 3-3
  - Couch/Bed Conversions . . . . . 6-2
  - Courtesy Blink Switch . . . . . 8-5
  - Courtesy Lights Switch . . . . . 8-5
  - Crank-out Side Windows . . . . . 6-3
  - Cruise Control . . . . . 8-2
- D**
- DC Electrical System, 12 Volt . . . . . 3-1
  - Doors, Care Of . . . . . 9-3
  - Door Handles and Locks . . . . . 8-11 to 8-13
  - Drain Valve Locations . . . . . 10-5, 10-6
  - Draperies, Care Of . . . . . 9-2
  - Dual Battery Switch . . . . . 3-7
- E**
- Electrical System, 12 Volt . . . . . 3-1
  - Electrical System, 110 Volt . . . . . 3-1
  - Electronic Information Center . . . . . 8-32
  - Electronic Instrument Display
    - Chieftain/Sunflyer . . . . . 8-24 to 8-26
    - Elandan/Windcruiser . . . . . 8-29 to 8-33
  - Electronic Speed Control (Cruise) . . . . . 8-2
  - Emergency Exits . . . . . 1-5
  - Engine Access . . . . . 9-4
  - Engine Cooling . . . . . 9-5
  - Engine Cover . . . . . 9-4
  - Entrance Step . . . . . 8-13

Equipment and Appliances	6-1
Exterior Body, Care Of	9-1
Exterior Feature Identification	0-3 to 0-6
External Utility Supply	3-1
<b>F</b>	
Fan, Auxiliary Defrost	8-5
Fire Extinguisher	1-6
Fold-Up Lavatory (Model 420RG)	6-2
Formaldehyde Warning	1-4
Fresh Air Vent	8-4
Front Bunks	6-1
Fuel Shut-Off Switch (Ford & John Deere Chassis)	8-1
Fuses, Automotive	9-12
Fuses, Coach	3-4
<b>G</b>	
Generator, Auxiliary 110 Volt	3-12
Ground Fault Circuit Interrupter	3-5
<b>H</b>	
Heater, Automotive	8-3, 8-4
Holding Tanks, Dumping	5-1
Hood	9-3
HWH Hydraulic Leveling System	8-6
<b>I</b>	
ICC Courtesy Blink Switch	8-5
Information Center, Electronic	8-32
Instrument Panels	8-18 to 8-33
Interior Furnishings	6-1
Introduction	0-1
<b>J</b>	
Jacking Points	9-6
<b>L</b>	
Lights, Maintenance of	9-12
Loading the Motor Home	7-1
Lounge Chairs, Adjustment	8-16

<b>LP Gas System</b>	
Fuel Selection	2-2
Traveling	2-3
Use of	2-1
Pressure Regulator	2-4
If You Smell Gas	1-3, 2-5
Leak Detector	2-5
Leak Troubleshooting	2-6
Winter Use	2-7
LP Gas Warnings	1-2, 2-1 to 2-8
Lubrication, Tag Axle Bearings	9-11
<b>M</b>	
Map Light Switch (Elandan/Windcruiser)	8-4
Mirrors, Remote Side	8-6
Monitor, Rear View	8-10
Multi-Function Signal Lever	8-2
<b>O</b>	
Oil Level, Checking	9-4
Overhead Bunks, Front	6-1
<b>P</b>	
Parking Brake, Automatic (John Deere Chassis)	8-1
Park & Level, operation	8-8
Power Control Center	3-3
Power Cord, External	1-3, 3-1
Power Seat Controls	8-16
Preparation, New Season	10-3
Pre-Travel Checklist	7-1
Procedures to Follow in Event of LP Leak	1-3, 2-5
Pull-Down Front Bunk (A-Body)	6-1
<b>R</b>	
Range, Care of	9-3
Rear Suspension (Tag Axle)	9-10, 9-11
Rear View Monitor System	8-10
Rear Window Wiper	8-6

Recovery Towing .....	9-8 to 9-10
Refrigerator, Care of .....	9-3
Refrigerator Compartment Door (Exterior) .....	6-3
Remote Controlled Side Mirrors .....	8-5, 8-6
Regulator, LP Gas .....	1-2, 2-4
Regulator, Water System .....	4-2
Roof, Care of .....	9-1
Roof Loading .....	7-2
Roof Vents, Powered .....	6-3
<b>S</b>	
Safety Precautions .....	1-1 to 1-6
Seats, Adjustment .....	8-10, 8-11
Seat Belts .....	8-11, 8-12
Sewer System, Use of .....	5-1
Signal Lever, Multi-Function .....	8-2
Sink, Care of .....	9-3
Speed Control .....	8-2
Storage Procedures .....	10-1
Storage, Removal from .....	10-3
Suspension, Air .....	9-10
Suspension Alignment .....	9-5
Swivel Seats, Adjustment .....	8-15, 8-16
<b>T</b>	
Tables and Countertops, Care of .....	9-3
Tag Axle (Model 37RQ) .....	9-10, 9-11
Tires .....	9-5
Tire Changing .....	9-6
Towing, Trailer .....	7-2
Towing, Vehicle Recovery .....	9-8 to 9-10
<b>U</b>	
Underbody, Care Of .....	9-1
Upholstery, Care Of .....	9-2
<b>V</b>	
Vacuum Gauge .....	8-11

Vehicle Certification Label .....	7-4, 7-5
Vent, Fresh Air .....	8-4
<b>W</b>	
<b>Warnings</b>	
Battery Servicing .....	3-7
Carbon Monoxide .....	1-4
Cooking Appliances .....	6-4
Electrical .....	1-3, 3-1 to 3-13
Emergency Exiting .....	1-5
Formaldehyde .....	1-4
Hydrogen Gas Formation .....	6-4
LP Gas .....	1-2, 2-1
LP Gas Filling .....	1-2, 2-3
Safety Precautions .....	1-1 to 1-6
Seat Belts .....	8-16, 8-17
Trailer Hitch .....	7-2
Wheel Nuts .....	9-8
Warranty .....	0-2
Washer, Windshield .....	8-2, 8-6
Water Heater Drain Valve .....	10-2
<b>Water System</b>	
Drain Valve Charts .....	10-5
External (City Connection) .....	4-2
Filling .....	4-1
Internal (Water Tanks) .....	4-1
Pump .....	4-1
Sanitizing .....	4-2
Windows, Care Of .....	9-3
Windows, Crank-Out .....	6-3
Windshield Washers .....	8-2, 8-6, 9-11
Windshield Wipers .....	8-2, 8-6, 9-11
Winnebago-Itasca Travelers (WIT) Club .....	0-2
Winterizing the Motor Home .....	10-1















